

SurePal™ 10 User's Guide

Instructions for use

en



SANDOZ A Novartis
Division

Personal notes

Please fill out before the first use of your SurePal™ 10:

Name of patient

Date of first use*

Use by date*

Lot number (see **LOT** on package)

Prescribed on

[date]

Dose [mg]

* The SurePal™ 10 can be used for two years from the date of first use.

It is highly recommended that patients receive training on the SurePal™ 10 prior to their first injection.

These instructions will help you use your SurePal™ 10 safely and correctly.

Read and follow all the instructions even if you have used a different type of injection pen.

If you don't follow these instructions, you may not get the proper dosage from your injections, and this may endanger your health.

Table of contents

What you need	4
Meet your SurePal™ 10	5
Safety precautions	8
SurePal™ 10 pen parts	9
1. Set the dose memory.....	10
2. Attach the cartridge.....	12
3. Prepare the cartridge.....	14
4. Give the injection	17
5. Prepare for storage.....	23
Exchange the cartridge.....	25
Inject the remaining dose.....	27
Storage and transport.....	28
Care and disposal.....	29
Troubleshooting	30
Warranty.....	31

What you need

Product contents

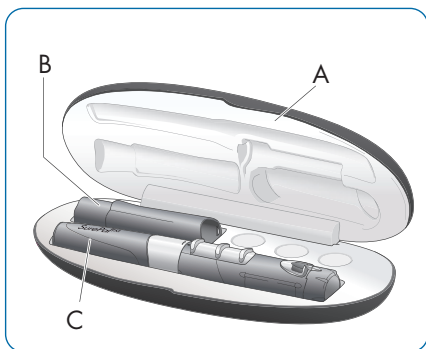

A Hard Case

B Needle Hider

C SurePal™ 10

Your SurePal™ 10 comes with a needle hider, a case, and a user's guide.

What you need to get from your pharmacy

- Omnitrope® (somatropin)
10 mg / 1.5 mL
- Alcohol wipe
- "Sharps container"
- Pen needles

Pen needle BD 29G

Needle length: 12.7 mm

Pen needle BD 31G

Needle lengths: 5 mm; 8 mm

Meet your SurePal™ 10

Intended use

SurePal™ 10 is intended for subcutaneous (under the skin) injection of a daily dose of Omnitrope® (rhGH drug). It is intended for patients (paediatric patients and adults) treated for growth disturbances and growth hormone deficiencies. The injection can be performed by the patient him/herself or also by a trained caregiver in case of small children or patients unable to perform the injection themselves.

The device is a multi-dose, needle-based injection system with automated functions to be used with the liquid formulation Omnitrope® in a standard 1.5 mL disposable pre-assembled cartridge.

Medication

The SurePal™ 10 should only be used with a pre-assembled Omnitrope® (somatropin) 10 mg / 1.5 mL cartridge. One pre-assembled cartridge holds multiple doses.

For more information about Omnitrope[®], see the package insert or speak to your doctor or pharmacist.

Package symbols and their meanings



Consult instructions for use



Warning of risks that arise when handling the SurePal[™] 10



Manufacturer



Date of manufacture



Catalogue number



Lot number



Keep away from sunlight



**DO NOT
FREEZE**

Do not freeze

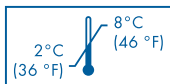

Temperature limits:
store within these
temperature limits



Pen needle

To prevent contamination, leave the pen needle in the package until just before you are going to use it.

General safety instructions

- Handle the SurePal™ 10 with care and keep it clean.
- Always wash your hands before using the SurePal™ 10.
- Use a new pen needle from a sterile package for each injection.



Safety precautions

Never share your SurePal™ 10!

The SurePal™ 10 should only be used by the patient for whom it was prescribed.

There is a considerable risk of transmission of infections if the SurePal™ 10 is shared with anyone else besides the intended patient.

If more than one person in your household uses a SurePal™ 10, make sure each device is labeled clearly so they can't be mixed up.



Advice for caregivers



If you are giving others their injections, take care and work with a steady hand.

Be careful not to accidentally stick yourself because this could result in spreading germs or infections.

Keep out of sight and reach of children.

SurePal™ 10 pen parts

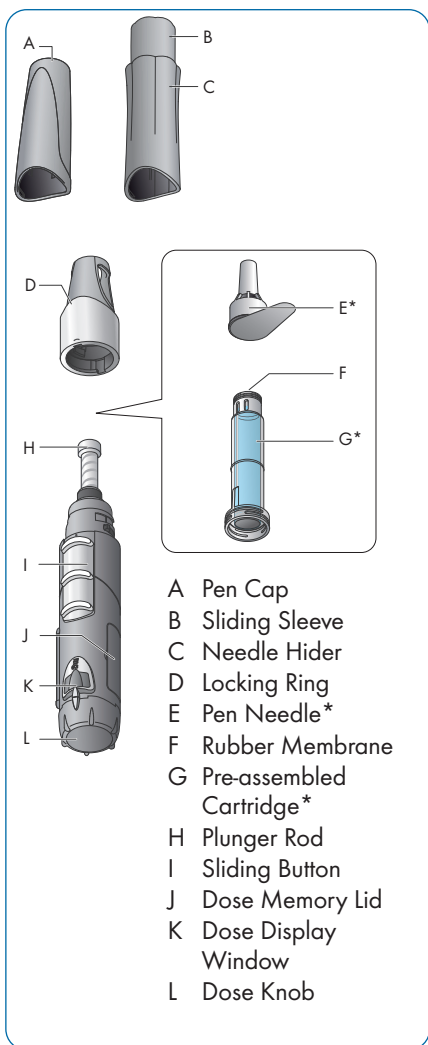

*parts to get from your pharmacy

1. Set the dose memory

- SurePal™ 10 features a dose memory function, which supports you in dialing the correct dose as prescribed by your doctor.
- Preset the dose before you use your SurePal™ 10 for the first time.
- If your doctor prescribes a new dose, change the dose memory.
- To set the dose memory on your SurePal™ 10, follow the instructions below.

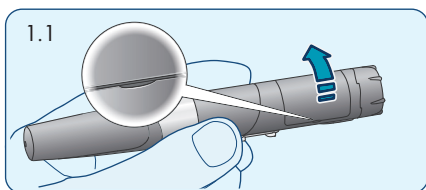

1.1 Open the dose memory lid. You can now access the dose setting wheel. Odd numbers are not shown but indicated by a dotted line ".....".

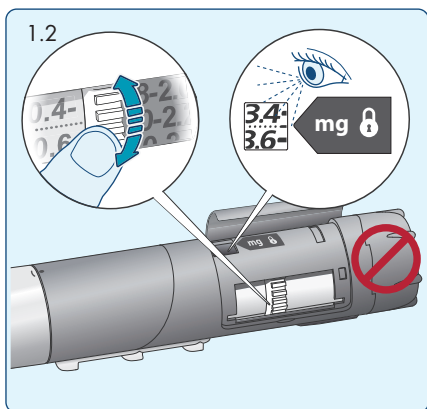

1.2 Turn the **white** dose setting wheel until the exact dose prescribed by your doctor is displayed and lines up with the **lock symbol** next to the dose memory window.

Note: Do not turn the dose knob, which is found on the end of the SurePal™ 10.

1.3 Close the dose memory lid. The dose is now pre-set and locked.

! Attention!

Make sure that the dose memory lid is securely closed. Otherwise, the pre-set dose could be changed accidentally.

2. Attach the cartridge

! Attention!



The pre-assembled cartridge should be removed from the refrigerator 30 minutes before use so that the solution inside can warm up to room temperature. An injection will hurt more if the solution that you're injecting is too cold.

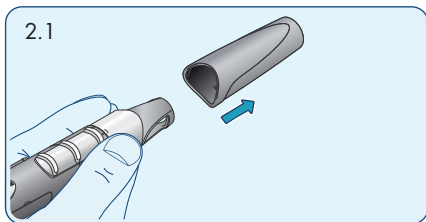

2.1 Remove the pen cap without turning it.

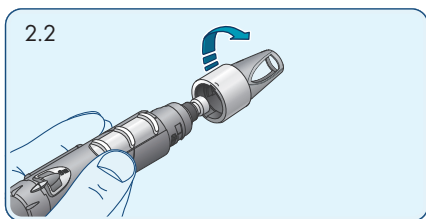

2.2 Unscrew the locking ring and put the SurePal™ 10 aside.

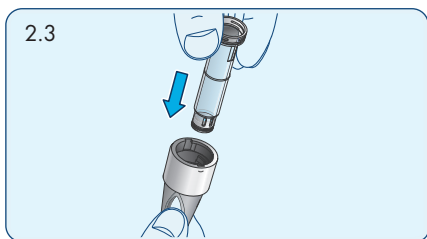

2.3 Insert the cartridge, narrow end first, into the locking ring.

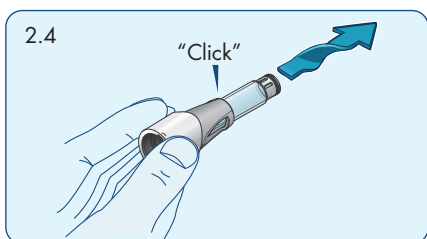

2.4 While turning the cartridge slightly, **pull** it into the locking ring until you hear a click.

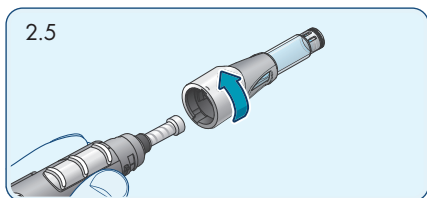

2.5 Screw the cartridge and locking ring onto the SurePal™ 10.

3. Prepare the cartridge

- Wash your hands.
- Make sure you have the following items:
 - A new pen needle
 - Alcohol wipe
 - A new pre-assembled cartridge if your SurePal™ 10 contains less than a complete dose
 - A leak-proof, puncture-resistant “sharps container” designed specifically for the safe disposal of used needles

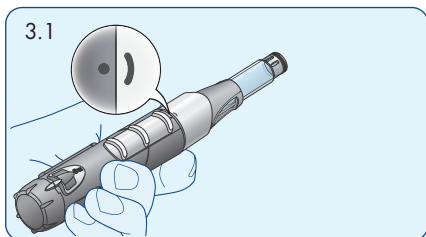

3.1 Make sure that the semi-circle on the locking ring exactly lines up with the dot on the SurePal™ 10.

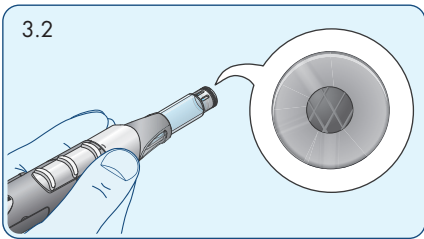

3.2 Wipe the grey tip of the pre-assembled cartridge with the alcohol wipe.

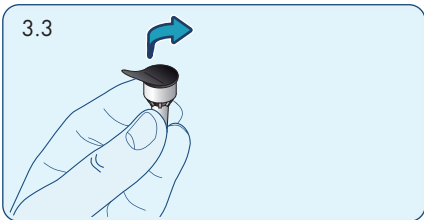

3.3 Remove the paper seal from the pen needle.

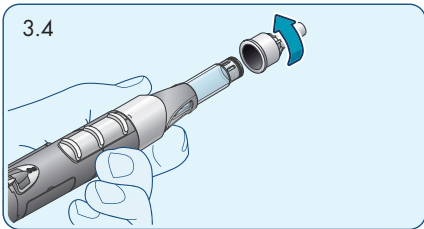

3.4 Screw the pen needle onto the pre-assembled cartridge.

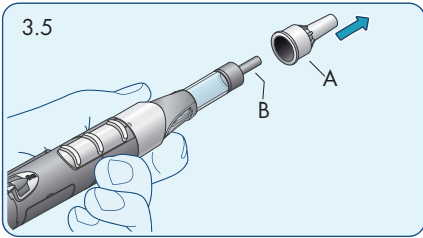

3.5 Pull the outer cap (A) off the needle and set it aside.

Do not remove the inner needle cap (B) yet.

4. Give the injection

4.1 Make sure the dose memory has been set (page 10).

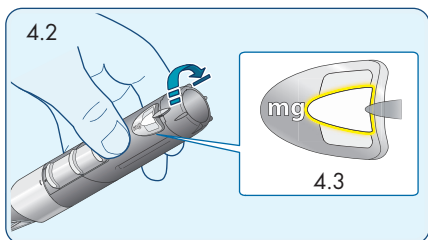

4.2 Position your trigger finger on the housing lid when holding the SurePal™ 10. Then gently turn the dose knob to the right until you feel a resistance.

4.3 Check the dose display window. The dose prescribed by the doctor should be displayed here.

Note: If the pre-set dose is not displayed, unscrew the pre-assembled cartridge and locking ring. Then push down on the sliding button until “0” is displayed in the dose display window. Then pre-set the prescribed dose correctly as described on page 10 of this guide.

4.4 Select an injection site, as recommended by your doctor (e.g. thigh or belly).

Note: Consider rotating the injection site from time to time as recommended by your doctor.

4.5 Disinfect the injection site and a small surrounding area.

Optional: With needle hider

If you don't want to see the pen needle while giving the injection, attach the needle hider.

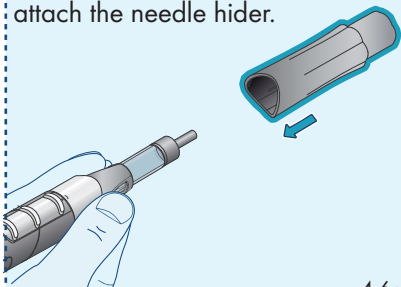

4.6a

Without needle hider

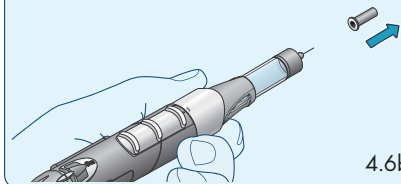

4.6b

4.6 Remove the inner needle cap.

Optional: With needle hider

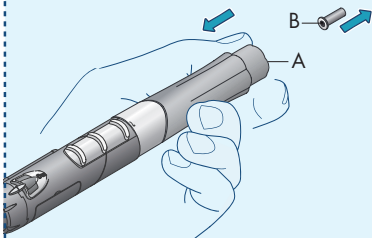

Pull the sliding sleeve of the needle hider (A) in a little bit so that you can remove the inner needle cap (B). See Figure 4.6b

4.6c

4.7 Discard the inner needle cap.

Attention!

After you remove the inner needle cap, do not set the SurePal™ 10 down and make sure that the needle does not touch anything. Take care not to unintentionally prick yourself on the exposed needle.

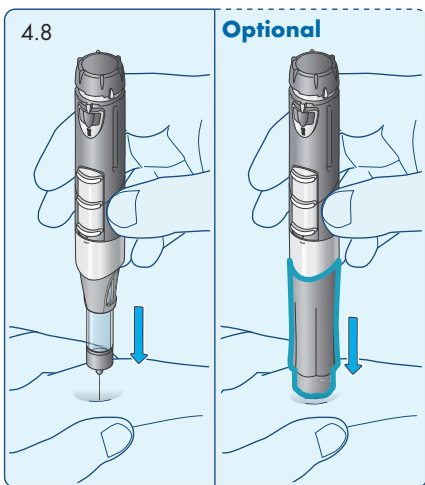

4.8 Pinch a fold of skin at the injection site with one hand.

4.9 Hold the SurePal™ 10 upright and insert the pen needle into the fold of the skin.

Note: If using the optional needle hider, insert the SurePal™ 10 into the fold of skin until the bottom (moveable) part is pushed all the way in. This will ensure that the needle is properly inserted.

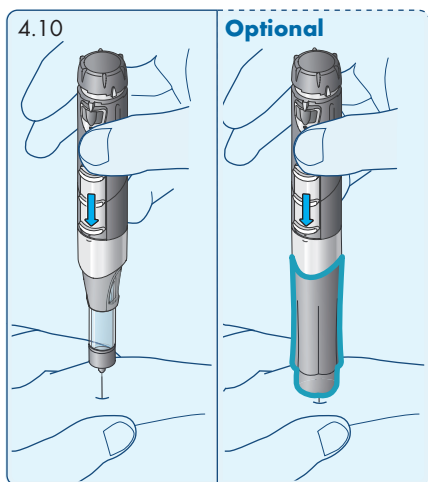

4.10 Push the sliding button down and hold it in this position. The dose knob will automatically turn until it stops.

Note: Once you push the sliding button down, the solution for injection is automatically injected. If you need to stop the injection, just release the sliding button. You can continue the injection by pushing the sliding button down again.

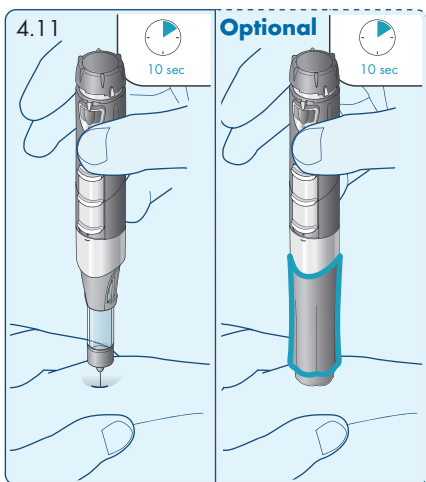

4.11 Hold the needle in for 10 seconds after the dose knob stops turning. The drug is injected when “0” appears in the dose display window.

4.12 Remove the pen needle from the fold of skin. You may observe some dripping from the pen needle. This is normal.

Note: If the dose display window does not show “0” you did not receive your complete dose. You will have to give two injections to get the complete prescribed dose. See page 27 “Inject the remaining dose”.

The first injection will stop when the cartridge is empty and the dose display window will show how much more must be injected to complete the dose. See page 27 “Inject the remaining dose”.

5. Prepare for storage

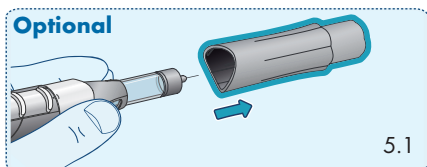

5.1 Carefully take off the needle hider.

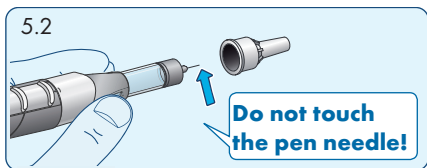

5.2 Carefully attach the outer needle cap.

! Attention!

Do not try to re-attach the inner needle cap. You could puncture yourself and possibly transmit germs.

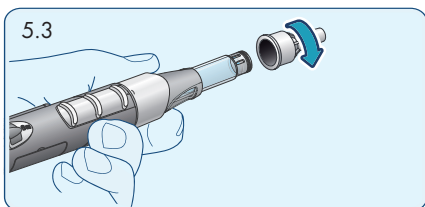

5.3 Immediately unscrew the pen needle while holding the locking ring firmly.

5.4 Dispose of the pen needle in a leak-proof, puncture-resistant “sharps container” designed specifically for the safe disposal of used needles.

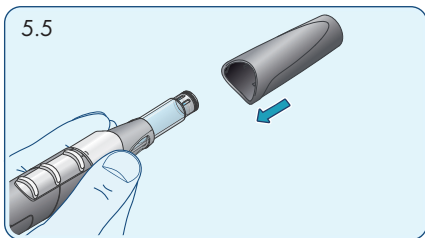

5.5 Re-attach the pen cap.

! Attention!

The SurePal™ 10 must **not** be stored with a pen needle attached.

If the SurePal™ 10 is stored with a pen needle attached, air can get into the pre-assembled cartridge and the solution for injection could leak out.

5.6 Place the SurePal™ 10 in its case and store it in the refrigerator with the cartridge still attached.

! Attention!



Once you have inserted a cartridge in the SurePal™ 10, it must be stored in a refrigerator at a temperature of 2–8 °C (36–46 °F). Make sure that the cartridge does not freeze. If it does, you should not use it any more. The contents of the pre-assembled cartridge must be used within 4 weeks (28 days) of the first use.

Exchange the cartridge

Exchange an empty cartridge

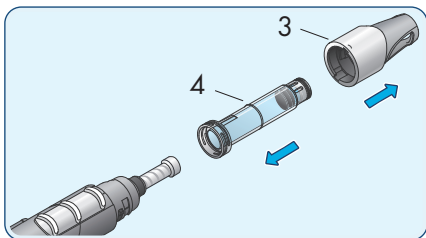
- 1** Attach outer needle cap.
- 2** Unscrew the pen needle and dispose of it in a “sharps container” page 24.





3 Unscrew the locking ring with the pre-assembled cartridge from the SurePal™ 10.

4 Remove the pre-assembled cartridge from the locking ring.

5 Dispose of the pre-assembled cartridge in the household trash.

Attach a new cartridge

6 Slide the new pre-assembled cartridge into the locking ring.

7 Pull the pre-assembled cartridge into the locking ring until you hear a click.



8 Screw the locking ring and attached pre-assembled cartridge onto the SurePal™ 10.



9 Make sure that the semi-circle on the locking ring exactly lines up with the dot on the SurePal™ 10.

Inject the remaining dose

If the dose knob stopped turning because of an empty pre-assembled cartridge, inject the remaining dose as follows:

1 Remove the empty pre-assembled cartridge page 25.

Note: Be careful not to trigger the sliding button as soon as you have removed the pre-assembled cartridge. Otherwise the remaining dose will be deleted.

2 Attach a new pre-assembled cartridge page 26.

The SurePal™ 10 will automatically keep track of how much of the dose still needs to be given to make a complete dose.

3 Attach a new pen needle.

4 Continue with the injection using the new pre-assembled cartridge page 17.

Note: Do not change the setting on the dose knob because it is still set to the amount required to complete the dose.

Storage and transport

Storage

Always store the SurePal™ 10 in its case, with the pen cap attached. Do not store the SurePal™ 10 with the needle attached. Store the SurePal™ 10 and the attached pre-assembled cartridge in the refrigerator at a temperature of 2–8 °C (36–46 °F). Make sure that the cartridge does not freeze. If it does freeze, you should not use it any more.

Storage period

The contents of the pre-assembled cartridge must be used within 4 weeks (28 days) of the first use. After 4 weeks the pre-assembled cartridge should be thrown away, even if it has not been used completely.

Transport and travel

The SurePal™ 10 with the attached pre-assembled cartridge should be transported in a cooler bag to make sure that it stays at the proper temperature without freezing. If it freezes, it should not be used again.

Care and disposal

Care

The SurePal™ 10 is a medical device and should be handled with care.

- Protect the SurePal™ 10 against light, dust, and contaminants.
- Clean the SurePal™ 10 and the needle hider with a dry, lint-free cloth. Do not use any liquids or cleaning agents.

Needle disposal

Collect the pen needles in a leak-proof, puncture-resistant “sharps container” designed specifically for the safe disposal of used needles.

“Sharps containers” can be purchased at most pharmacies and other select retailers.

Keep the “sharps container” out of reach of children.

Dispose of empty pre-assembled cartridges with your household waste.

Troubleshooting

The dose knob is hard to turn:

Liquid may have leaked into the SurePal™ 10. If so, exchange your SurePal™ 10 for another one.

In case the knob stops unexpectedly, check if the cartridge is empty:

If it is not empty, please replace the needle and continue injection.

The pen needle is still dripping when the injection is finished:

Next time you give an injection, leave the needle in the skin for about 10 seconds longer. See page 17.

The pre-assembled cartridge doesn't fit:

You may be trying to insert an incompatible pre-assembled cartridge. The SurePal™ 10 is only compatible with the pre-assembled cartridge listed on page 5.

The pre-assembled cartridge is damaged:

Never use a pre-assembled cartridge that is damaged in any way (e.g. broken glass)! Pre-assembled cartridges should be handled with care at all times.



The dose display window of the SurePal™ 10 does not show the pre-set dose:

The dose memory lid may not be closed properly. If you can't get the dose memory lid to close securely or the dose displayed is incorrect for some other reason, stop using your SurePal™ 10 and exchange it for a new one.

Warranty

The SurePal™ 10 comes with a 2-year warranty. After 2 years of use, return to the place where you obtained your SurePal™ 10 and exchange it for a new one.

If you should discover any material or manufacturing defects in your SurePal™ 10 within the warranty period, you will receive a replacement at no charge.

This warranty shall not apply if the SurePal™ 10 is not used in accordance with the instructions for use or if the defect occurs as the result of negligence, misuse, or accidental damage.

CE 0123

Rev. 2020-07

Manufacturer



Sandoz GmbH
Biochemiestrasse 10
A-6250 Kundl
Austria

+43 (0)5338 200

www.sandoz.com

Distributor

Sandoz Limited
Park View, Riverside Way
Watchmoor Park
Camberley, Surrey
GU15 3YL
United Kingdom

The SurePal™ 10 complies with the accuracy requirements of the International Standard ISO 11608-1.

46302849