

## Package leaflet: Information for the user

### Cosentyx® 150 mg solution for injection in pre-filled syringe

secukinumab

**Read all of this leaflet carefully before you start using this medicine because it contains important information for you.**

- Keep this leaflet. You may need to read it again.
- If you have any further questions, ask your doctor, pharmacist or nurse.
- This medicine has been prescribed for you only. Do not pass it on to others. It may harm them, even if their signs of illness are the same as yours.
- If you get any side effects, talk to your doctor, pharmacist or nurse. This includes any possible side effects not listed in this leaflet. See section 4.

#### **What is in this leaflet**

1. What Cosentyx is and what it is used for
2. What you need to know before you use Cosentyx
3. How to use Cosentyx
4. Possible side effects
5. How to store Cosentyx
6. Contents of the pack and other information

#### **1. What Cosentyx is and what it is used for**

Cosentyx contains the active substance secukinumab. Secukinumab is a monoclonal antibody which belongs to a group of medicines called interleukin (IL) inhibitors. This medicine works by neutralising the activity of a protein called IL-17A, which is present at increased levels in diseases such as psoriasis, hidradenitis suppurativa, psoriatic arthritis and axial spondyloarthritis.

Cosentyx is used for the treatment of the following inflammatory diseases:

- Plaque psoriasis
- Hidradenitis suppurativa
- Psoriatic arthritis
- Axial spondyloarthritis, including ankylosing spondylitis (radiographic axial spondyloarthritis) and non-radiographic axial spondyloarthritis
- Juvenile idiopathic arthritis, including enthesitis-related arthritis and juvenile psoriatic arthritis

#### **Plaque psoriasis**

Cosentyx is used to treat a skin condition called “plaque psoriasis”, which causes inflammation affecting the skin. Cosentyx reduces the inflammation and other symptoms of the disease. Cosentyx is used in adults, adolescents and children (6 years of age and older) with moderate to severe plaque psoriasis.

Using Cosentyx in plaque psoriasis will benefit you by leading to improvements of skin clearance and reducing your symptoms such as scaling, itching and pain.

#### **Hidradenitis suppurativa**

Cosentyx is used to treat a condition called hidradenitis suppurativa, also sometimes called acne inversa or Verneuil’s disease. This condition is a chronic and painful inflammatory skin disease. Symptoms may include tender nodules (lumps) and abscesses (boils) that may leak pus. It commonly affects specific areas of the skin, such as under the breasts, the armpits, inner thighs, groin and buttocks. Scarring may also occur in affected areas.

Cosentyx can reduce the number of nodules and abscesses you have and the pain that is often associated

with the disease. If you have hidradenitis suppurativa you will first be given other medicines. If you do not respond well enough to these medicines, you will be given Cosentyx.

Cosentyx is used in adults with hidradenitis suppurativa and can be used alone or with antibiotics.

### **Psoriatic arthritis**

Cosentyx is used to treat a condition called “psoriatic arthritis”. The condition is an inflammatory disease of the joints, often accompanied by psoriasis. If you have active psoriatic arthritis you will first be given other medicines. If you do not respond well enough to these medicines, you will be given Cosentyx to reduce the signs and symptoms of active psoriatic arthritis, improve physical function and slow down the damage to the cartilage and bone of the joints involved in the disease.

Cosentyx is used in adults with active psoriatic arthritis and can be used alone or with another medicine called methotrexate.

Using Cosentyx in psoriatic arthritis will benefit you by reducing the signs and symptoms of the disease, slowing down the damage to the cartilage and bone of the joints and improving your ability to do normal daily activities.

### **Axial spondyloarthritis, including ankylosing spondylitis (radiographic axial spondyloarthritis) and non-radiographic axial spondyloarthritis**

Cosentyx is used to treat conditions called “ankylosing spondylitis” and “non-radiographic axial spondyloarthritis”. These conditions are inflammatory diseases primarily affecting the spine which cause inflammation of the spinal joints. If you have ankylosing spondylitis or non-radiographic axial spondyloarthritis you will first be given other medicines. If you do not respond well enough to these medicines, you will be given Cosentyx to reduce the signs and symptoms of the disease, reduce inflammation and improve your physical function.

Cosentyx is used in adults with active ankylosing spondylitis and active non-radiographic axial spondyloarthritis.

Using Cosentyx in ankylosing spondylitis and non-radiographic axial spondyloarthritis will benefit you by reducing the signs and symptoms of your disease and improving your physical function.

### **Juvenile idiopathic arthritis, including enthesitis-related arthritis and juvenile psoriatic arthritis**

Cosentyx is used in patients (6 years of age and older) to treat conditions of the juvenile idiopathic arthritis categories called “enthesitis-related arthritis” and “juvenile psoriatic arthritis”. These conditions are inflammatory diseases affecting the joints and the places where tendons join the bone.

Using Cosentyx in enthesitis-related arthritis and juvenile psoriatic arthritis will benefit you (or your child) by reducing the symptoms and improving your (or your child's) physical function.

## **2. What you need to know before you use Cosentyx**

### **Do not use Cosentyx:**

- **if you are allergic** to secukinumab or any of the other ingredients of this medicine (listed in section 6).  
If you think you may be allergic, ask your doctor for advice before using Cosentyx.
- **if you have an active infection** which your doctor thinks is important.

### **Warnings and precautions**

Talk to your doctor, nurse or pharmacist before using Cosentyx:

- if you currently have an infection.
- if you have long-term or repeated infections.
- if you have tuberculosis.

- if you have ever had an allergic reaction to latex.
- if you have an inflammatory disease affecting your gut called Crohn’s disease.
- if you have an inflammation of your large intestine called ulcerative colitis.
- if you have recently had a vaccination or if you are due to have a vaccination during treatment with Cosentyx.
- if you are receiving any other treatment for psoriasis, such as another immunosuppressant or phototherapy with ultraviolet (UV) light.

**Inflammatory bowel disease (Crohn’s disease or ulcerative colitis)**

Stop using Cosentyx and tell your doctor or seek medical help immediately if you notice abdominal cramps and pain, diarrhoea, weight loss, blood in the stool or any other signs of bowel problems.

**Look out for infections and allergic reactions**

Cosentyx can potentially cause serious side effects, including infections and allergic reactions. You must look out for signs of these conditions while you are taking Cosentyx.

Stop using Cosentyx and tell your doctor or seek medical help immediately if you notice any signs indicating a possible serious infection or an allergic reaction. Such signs are listed under “Serious side effects” in section 4.

**Children and adolescents**

Cosentyx is not recommended for children younger than 6 years of age with plaque psoriasis because it has not been studied in this age group.

Cosentyx is not recommended for children younger than 6 years of age with juvenile idiopathic arthritis (enthesitis related arthritis and juvenile psoriatic arthritis).

Cosentyx is not recommended for children and adolescents (under 18 years of age) in other indications because it has not been studied in this age group.

**Other medicines and Cosentyx**

Tell your doctor or pharmacist:

- if you are taking, have recently taken or might take any other medicines.
- if you have recently had or are due to have a vaccination. You should not be given certain types of vaccines (live vaccines) while using Cosentyx.

**Pregnancy, breast-feeding and fertility**

- It is preferable to avoid the use of Cosentyx in pregnancy. The effects of this medicine in pregnant women are not known. If you are a woman of childbearing potential, you are advised to avoid becoming pregnant and must use adequate contraception while using Cosentyx and for at least 20 weeks after the last Cosentyx dose.

Talk to your doctor if you are pregnant, think you may be pregnant or are planning to have a baby.

- Talk to your doctor if you are breast-feeding or are planning to breast-feed. You and your doctor should decide if you will breast-feed or use Cosentyx. You should not do both. After using Cosentyx you should not breast-feed for at least 20 weeks after the last dose.

**Driving and using machines**

Cosentyx is unlikely to influence your ability to drive and use machines.

**3. How to use Cosentyx**

Always use this medicine exactly as your doctor has told you. Check with your doctor, nurse or pharmacist if you are not sure.

Cosentyx is given via injection under your skin (known as a subcutaneous injection). You and your doctor should decide if you should inject Cosentyx yourself.

It is important not to try to inject yourself until you have been trained by your doctor, nurse or pharmacist. A caregiver may also give you your Cosentyx injection after proper training.

For detailed instructions on how to inject Cosentyx, see “Instructions for use of Cosentyx 150 mg pre-filled syringe” at the end of this leaflet.

### **How much Cosentyx is given and for how long**

Your doctor will decide how much Cosentyx you need and for how long.

#### Plaque psoriasis

##### Adult

- The recommended dose is 300 mg by subcutaneous injection.
- Each 300 mg dose **is given as two injections of 150 mg.**

After the first dose you will receive further weekly injections at weeks 1, 2, 3 and 4 followed by monthly injections. Based on your response, further adjustments to your dose may be recommended by your doctor. At each timepoint you will receive a 300 mg dose given as two injections of 150 mg.

#### Children aged 6 years and older

- The recommended dose is based on body weight as follows:
  - Weight below 25 kg: 75 mg by subcutaneous injection.
  - Weight 25 kg or above and below 50 kg: 75 mg by subcutaneous injection.
  - Weight 50 kg or above: 150 mg by subcutaneous injection.Your doctor may increase the dose to 300 mg.
- Each 150 mg dose **is given as one injection of 150 mg.** Other dosage forms/strengths may be available for administration of the 75 mg and 300 mg doses.

After the first dose you will receive further weekly injections at weeks 1, 2, 3 and 4 followed by monthly injections.

#### Hidradenitis suppurativa

- The recommended dose is 300 mg by subcutaneous injection.
- Each 300 mg dose **is given as two injections of 150 mg.**

After the first dose you will receive further weekly injections at weeks 1, 2, 3 and 4 followed by monthly injections. Based on your response, further adjustments to your dose may be recommended by your doctor.

#### Psoriatic arthritis

If you have both psoriatic arthritis and also moderate to severe plaque psoriasis, your doctor may adjust the dose recommendation as needed.

For patients who did not respond well to medicines called tumour necrosis factor (TNF) blockers:

- The recommended dose is 300 mg by subcutaneous injection.
- Each 300 mg dose **is given as two injections of 150 mg.**

After the first dose you will receive further weekly injections at weeks 1, 2, 3 and 4 followed by monthly injections. At each timepoint you will receive a 300 mg dose given as two injections of 150 mg.

For other psoriatic arthritis patients:

- The recommended dose is 150 mg by subcutaneous injection.

After the first dose you will receive further weekly injections at weeks 1, 2, 3 and 4 followed by monthly injections.

Based on your response, your doctor may increase your dose to 300 mg.

Ankylosing spondylitis (Radiographic axial spondyloarthritis)

- The recommended dose is 150 mg by subcutaneous injection.

After the first dose you will receive further weekly injections at weeks 1, 2, 3 and 4 followed by monthly injections.

Based on your response, your doctor may increase your dose to 300 mg. Each 300 mg dose is given as two injections of 150 mg.

Non-radiographic axial spondyloarthritis

- The recommended dose is 150 mg by subcutaneous injection.

After the first dose you will receive further weekly injections at weeks 1, 2, 3 and 4 followed by monthly injections.

Juvenile idiopathic arthritis (enthesitis-related arthritis and juvenile psoriatic arthritis)

- The recommended dose is based on body weight as follows:
  - Weight below 50 kg: 75 mg by subcutaneous injection.
  - Weight 50 kg or above: 150 mg by subcutaneous injection.
- Each 150 mg dose **is given as one injection of 150 mg**. Other dosage forms/strengths may be available for administration of the 75 mg dose.

After the first dose you will receive further weekly injections at weeks 1, 2, 3 and 4 followed by monthly injections.

Cosentyx is for long-term treatment. Your doctor will regularly monitor your condition to check that the treatment is having the desired effect.

**If you use more Cosentyx than you should**

If you have received more Cosentyx than you should or the dose has been administered sooner than according to your doctor's prescription, inform your doctor.

**If you forget to use Cosentyx**

If you have forgotten to inject a dose of Cosentyx, inject the next dose as soon as you remember. Then talk to your doctor to discuss when you should inject the next dose.

**If you stop using Cosentyx**

It is not dangerous to stop using Cosentyx. However, if you stop, your psoriasis, psoriatic arthritis or axial spondyloarthritis symptoms may come back.

If you have any further questions on the use of this medicine, ask your doctor, pharmacist or nurse.

**4. Possible side effects**

Like all medicines, this medicine can cause side effects, although not everybody gets them.

## **Serious side effects**

Stop using Cosentyx and tell your doctor or seek medical help immediately if you get any of the following side effects:

**Possible serious infection** - the signs may include:

- fever, flu-like symptoms, night sweats
- feeling tired or short of breath, cough which will not go away
- warm, red and painful skin, or a painful skin rash with blisters
- burning sensation when passing urine.

**Serious allergic reaction** - the signs may include:

- difficulty breathing or swallowing
- low blood pressure, which can cause dizziness or light-headedness
- swelling of the face, lips, tongue or throat
- severe itching of the skin, with a red rash or raised bumps.

Your doctor will decide if and when you may restart the treatment.

## **Other side effects**

Most of the following side effects are mild to moderate. If any of these side effects becomes severe, tell your doctor, pharmacist or nurse.

**Very common** (may affect more than 1 in 10 people):

- upper respiratory tract infections with symptoms such as sore throat and stuffy nose (nasopharyngitis, rhinitis)

**Common** (may affect up to 1 in 10 people):

- cold sores (oral herpes)
- diarrhoea
- runny nose (rhinorrhoea)
- headache
- nausea
- fatigue

**Uncommon** (may affect up to 1 in 100 people):

- oral thrush (oral candidiasis)
- signs of low levels of white blood cells, such as fever, sore throat or mouth ulcers due to infections (neutropenia)
- infection of the external ear (otitis externa)
- discharge from the eye with itching, redness and swelling (conjunctivitis)
- itchy rash (urticaria)
- lower respiratory tract infections
- abdominal cramps and pain, diarrhoea, weight loss or blood in the stool (signs of bowel problems)
- small, itchy blisters on the palms of hands, soles of feet and edges of the fingers and toes (dyshidrotic eczema)
- athlete's foot (tinea pedis)

**Rare** (may affect up to 1 in 1 000 people):

- severe allergic reaction with shock (anaphylactic reaction)
- redness and shedding of skin over a larger area of the body, which may be itchy or painful (exfoliative dermatitis)
- inflammation of small blood vessels, which can lead to a skin rash with small red or purple bumps (vasculitis)

**Not known** (frequency cannot be estimated from the available data):

- fungal infections of the skin and mucous membranes (including oesophageal candidiasis)
- painful swelling and skin ulceration

### **Reporting of side effects**

If you get any side effects, talk to your doctor, pharmacist or nurse. This includes any possible side effects not listed in this leaflet. You can also report side effects directly via the Yellow Card Scheme at: [www.mhra.gov.uk/yellowcard](http://www.mhra.gov.uk/yellowcard) or search for MHRA Yellow Card in the Google Play or Apple App Store. By reporting side effects you can help provide more information on the safety of this medicine.

## **5. How to store Cosentyx**

Keep this medicine out of the sight and reach of children.

Do not use this medicine:

- after the expiry date which is stated on the outer box or the label on the syringe after “EXP”.
- if the liquid contains easily visible particles, is cloudy or is distinctly brown.

Store the syringe sealed in its box to protect from light. Store in the refrigerator between 2°C and 8°C. Do not freeze. Do not shake.

If necessary, Cosentyx can be left out of the refrigerator for a single period of up to 4 days at room temperature, not above 30°C.

This medicine is for single use only.

Do not throw away any medicines via wastewater. Ask your pharmacist how to throw away medicines you no longer use. These measures will help protect the environment.

## **6. Contents of the pack and other information**

### **What Cosentyx contains**

- The active substance is secukinumab. Each pre-filled syringe contains 150 mg secukinumab.
- The other ingredients are trehalose dihydrate, histidine, histidine hydrochloride monohydrate, methionine, polysorbate 80 and water for injections.

### **What Cosentyx looks like and contents of the pack**

Cosentyx solution for injection is a clear liquid. Its colour may vary from colourless to slightly yellow. Cosentyx 150 mg solution for injection in pre-filled syringe is available in unit packs containing 1 or 2 pre-filled syringe(s) and in multipacks containing 6 (3 packs of 2) pre-filled syringes. Not all pack sizes may be marketed.

### **Marketing Authorisation Holder**

Novartis Pharmaceuticals UK Limited  
2nd Floor, The WestWorks Building, White City Place  
195 Wood Lane  
London  
W12 7FQ  
United Kingdom

### **Manufacturer**

Sandoz GmbH  
Biochemiestrasse 10  
6336 Langkampfen

Austria

Novartis Pharmaceuticals UK Limited  
2nd Floor, The WestWorks Building,  
White City Place, 195 Wood Lane,  
London, W12 7FQ  
United Kingdom

For any information about this medicine, please contact the local representative of the Marketing Authorisation Holder:

**United Kingdom**

Novartis Pharmaceuticals UK Ltd.  
Tel: +44 1276 698370

**This leaflet was last revised in 05/2023**



## Instructions for use of Cosentyx 150 mg pre-filled syringe

Read ALL the way through these instructions before injecting. It is important not to try to inject yourself or a person in your care until you have been trained by your doctor, nurse or pharmacist. The box contains Cosentyx 150 mg pre-filled syringe(s) individually sealed in a plastic blister.

### Your Cosentyx 150 mg pre-filled syringe

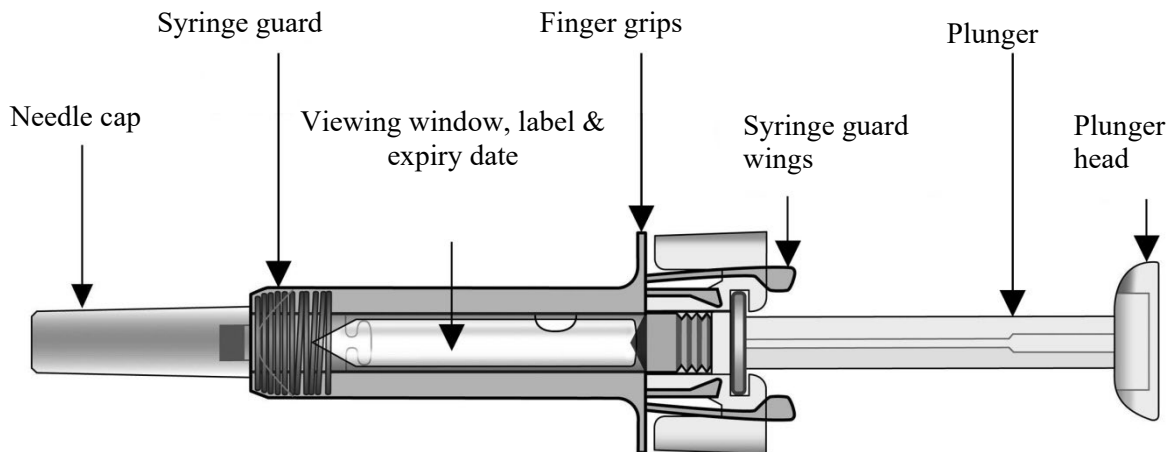

After the medicine has been injected the syringe guard will be activated to cover the needle. This is intended to aid in the protection of healthcare professionals, patients who self-inject doctor-prescribed medicines, and individuals who assist self-injecting patients from accidental needlestick injuries.

#### What you additionally need for your injection:

- Alcohol swab.
- Cotton ball or gauze.
- Sharps disposal container.



+



+



#### Important safety information

**Caution: Keep the syringe out of the sight and reach of children.**

1. The needle cap of the syringe may contain dry rubber (latex), which should not be handled by persons sensitive to this substance.
2. Do not open the sealed outer box until you are ready to use this medicine.
3. Do not use this medicine if either the seal on the outer box or the seal of the blister is broken, as it may not be safe for you to use.
4. Do not use if the syringe has been dropped onto a hard surface or dropped after removing the needle cap.
5. Never leave the syringe lying around where others might tamper with it.
6. Do not shake the syringe.
7. Be careful not to touch the syringe guard wings before use. By touching them, the syringe guard may be activated too early.
8. Do not remove the needle cap until just before you give the injection.
9. The syringe cannot be re-used. Dispose of the used syringe immediately after use in a sharps container.

#### Storage of the Cosentyx 150 mg pre-filled syringe

1. Store this medicine sealed in its outer box to protect it from light. Store in the refrigerator

between 2°C and 8°C. DO NOT FREEZE.

- Remember to take the syringe out of the refrigerator and allow it to reach room temperature before preparing it for injection (15-30 minutes).
- Do not use the syringe after the expiry date which is stated on the outer box or syringe label after “EXP”. If it has expired, return the entire pack to the pharmacy.

### The injection site

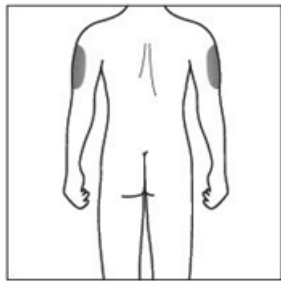
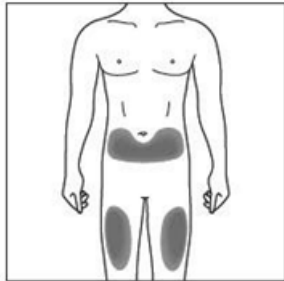

The injection site is the place on the body where you are going to use the syringe.

- The recommended site is the front of your thighs. You may also use the lower abdomen, but **not** the area 5 centimetres around the navel (belly button).
- Choose a different site each time you give yourself an injection.
- Do not inject into areas where the skin is tender, bruised, red, scaly or hard. Avoid areas with scars or stretch marks.

If a caregiver is giving you the injection, the outer upper arms may also be used.

### Preparing the Cosentyx 150 mg pre-filled syringe ready for use

Note: For a 150 mg dose, prepare 1 pre-filled syringe and inject the content. For a 300 mg dose, prepare 2 pre-filled syringes and inject the contents of both.

- Take the box containing the syringe out of the refrigerator and leave it **unopened** for about 15-30 minutes so that it reaches room temperature.
- When you are ready to use the syringe, wash your hands thoroughly with soap and water.
- Clean the injection site with an alcohol swab.
- Remove the syringe from the outer box and take it out of the blister by holding the syringe guard body.
- Inspect the syringe. The liquid should be clear. Its colour may vary from colourless to slightly yellow. You may see a small air bubble, which is normal. **DO NOT USE** if the liquid contains easily visible particles, is cloudy or is distinctly brown. **DO NOT USE** if the syringe is broken. In all these cases, return the entire product pack to the pharmacy.

### How to use the Cosentyx 150 mg pre-filled syringe

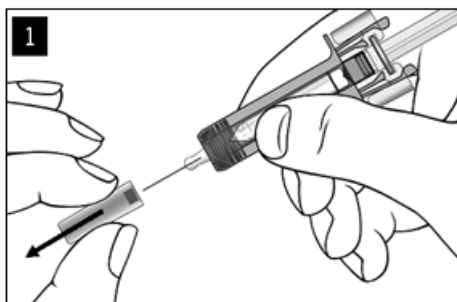

Carefully remove the needle cap from the syringe by holding the syringe guard body. Discard the needle cap. You may see a drop of liquid at the end of the needle. This is normal.

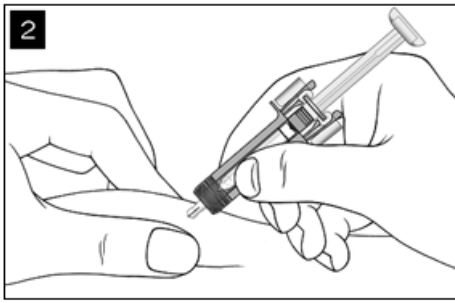

Gently pinch the skin at the injection site and insert the needle as shown. Push the needle all the way in to ensure that the medicine can be fully administered.

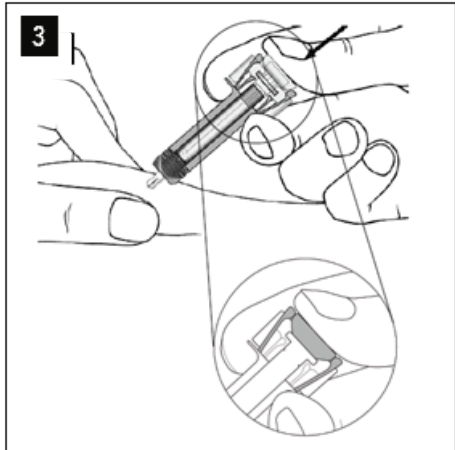

Hold the syringe as shown. **Slowly** depress the plunger **as far as it will go** so that the plunger head is completely between the syringe guard wings. Keep the plunger pressed fully down while you hold the syringe in place for 5 seconds.

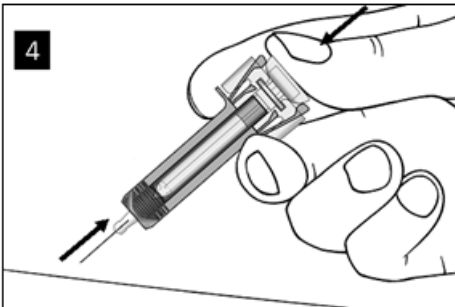

**Keep the plunger fully depressed** while you carefully lift the needle straight out from the injection site.



Slowly release the plunger and allow the syringe guard to automatically cover the exposed needle.

There may be a small amount of blood at the injection site. You can press a cotton ball or gauze over the injection site and hold it for 10 seconds. Do not rub the injection site. You may cover the injection site with a small adhesive bandage, if needed.

### Disposal instructions



Dispose of the used syringe in a sharps container (closable, puncture resistant container). For the safety and health of you and others, needles and used syringes **must never** be re-used.

