

Package leaflet: Information for the user

Bemfola 75 IU/0.125 mL solution for injection in pre-filled pen
Bemfola 150 IU/0.25 mL solution for injection in pre-filled pen
Bemfola 225 IU/0.375 mL solution for injection in pre-filled pen
Bemfola 300 IU/0.50 mL solution for injection in pre-filled pen
Bemfola 450 IU/0.75 mL solution for injection in pre-filled pen

follitropin alfa

Read all of this leaflet carefully before you start using this medicine because it contains important information for you.

- Keep this leaflet. You may need to read it again.
- If you have any further questions, ask your doctor or pharmacist.
- This medicine has been prescribed for you only. Do not pass it on to others. It may harm them, even if their signs of illness are the same as yours.
- If you get any side effects, talk to your doctor or pharmacist. This includes any possible side effects not listed in this leaflet. See section 4.

What is in this leaflet

1. What Bemfola is and what it is used for
2. What you need to know before you use Bemfola
3. How to use Bemfola
4. Possible side effects
5. How to store Bemfola
6. Contents of the pack and other information

1. What Bemfola is and what it is used for

What Bemfola is

This medicine contains the active substance follitropin alfa, which is almost identical to a natural hormone produced by your body called “follicle-stimulating hormone” (FSH). FSH is a gonadotropin, a type of hormone that plays an important role in human fertility and reproduction. In women, FSH is needed for the growth and development of the sacs (follicles) in the ovaries that contain the egg cells. In men, FSH is needed for the production of sperm.

What Bemfola is used for

In adult women, Bemfola is used:

- to help release an egg from the ovary (ovulation) in women that cannot ovulate and that did not respond to treatment with a medicine called “clomiphene citrate”.
- together with another medicine called “lutropin alfa” (“luteinising hormone” or LH) to help release an egg from the ovary (ovulation) in women whose body is producing very little gonadotropins (FSH and LH).
- to help develop several follicles (each containing an egg) in women undergoing assisted reproductive technology procedures (procedures that may help you to become pregnant) such as “in vitro fertilisation”, “gamete intra-fallopian transfer” or “zygote intra-fallopian transfer”.

In adult men, Bemfola is used:

- together with another medicine called “human chorionic gonadotropin” (hCG) to help produce sperm in men that are infertile due to a low level of certain hormones.

2. What you need to know before you use Bemfola

You and your partner's fertility should be evaluated before the treatment is started by a doctor experienced in treating fertility disorders.

Do not use Bemfola

- if you are allergic to follicle stimulating hormone or any of the other ingredients of this medicine (listed in section 6).
- if you have a tumour in your hypothalamus or pituitary gland (both are parts of the brain).
- if you are **a woman**:
 - with large ovaries or sacs of fluids within the ovaries (ovarian cysts) of unknown origin.
 - with unexplained vaginal bleeding.
 - with cancer in your ovaries, womb or breasts.
 - with a condition that usually makes normal pregnancy impossible, such as ovarian failure (early menopause), or malformed reproductive organs.
- if you are **a man**:
 - with damaged testicles that cannot be healed.

Do not use Bemfola if any of the above applies to you. If you are not sure, talk to your doctor before using this medicine.

Warnings and precautions

Talk to your doctor or pharmacist before using Bemfola.

Porphyria

Tell your doctor before you start treatment, if you or any member of your family have porphyria (an inability to break down porphyrins that may be passed on from parents to children).

Tell your doctor straight away if:

- your skin becomes fragile and easily blistered, especially skin that has been frequently in the sun, and/or
- you have stomach, arm or leg pain.

In case of the above events your doctor may recommend that you stop treatment.

Ovarian hyper-stimulation syndrome (OHSS)

If you are a woman, this medicine increases your risk of developing OHSS. This is when your follicles develop too much and become large cysts. If you get lower abdominal pain, gain any weight rapidly, feel sick or are vomiting or if you have difficulty in breathing, talk to your doctor straight away who might ask you to stop using this medicine (see section 4).

In case you are not ovulating, and if the recommended dose and schedule of administration are adhered to, the occurrence of OHSS is less likely. Bemfola treatment seldom causes severe OHSS unless the medicine that is used for final follicular maturation (containing human chorionic gonadotropin, hCG) is administered. If you are developing OHSS your doctor may not give you any hCG in this treatment cycle and you may be told not to have sex or to use a barrier contraceptive method for at least four days.

Multiple pregnancy

When using Bemfola, you have a higher risk of being pregnant with more than one child at the same time ("multiple pregnancy", mostly twins), than if you conceived naturally. Multiple pregnancy may lead to medical complications for you and your babies. You can reduce the risk of multiple pregnancy by using the right dose of Bemfola at the right times. When undergoing assisted reproductive technology, the risk of having a multiple pregnancy is related to your age, the quality and the number of fertilised eggs or embryos placed inside you.

Miscarriage

When undergoing assisted reproductive technology or stimulation of your ovaries to produce eggs, you are more likely to have a miscarriage than the average woman.

Blood clotting problems (thromboembolic events)

If you had in the past or recently blood clots in the leg or in the lung, or a heart attack or stroke, or if those happened in your family, then you might have a higher risk that these problems occur or become worse with Bemfola treatment.

Men with too much FSH in their blood

If you are a man, having too much FSH in your blood can be a sign of damaged testicles. Bemfola usually does not work if you have this problem. If your doctor decides to try Bemfola treatment, to monitor the treatment, they may ask you to provide semen for analysis 4 to 6 months after starting treatment.

Children and adolescents

Bemfola is not indicated for use in children and adolescents below 18 years old.

Other medicines and Bemfola

Tell your doctor if you are taking, have recently taken or might take any other medicines.

- If you use Bemfola with other medicines which help ovulation (such as hCG or clomiphene citrate), this may increase the response of your follicles.
- If you use Bemfola at the same time as a “gonadotropin-releasing hormone” (GnRH) agonist or antagonist (these medicines reduce your sex hormone levels and stop you ovulating) you may need a higher dose of Bemfola to produce follicles.

Pregnancy and breast-feeding

Do not use Bemfola if you are pregnant or breast-feeding.

Driving and using machines

It is not expected that this medicine will affect your ability to drive and use machines.

Bemfola contains sodium

This medicine contains less than 1 mmol sodium (23 mg) per dose, that is to say essentially “sodium-free”.

3. How to use Bemfola

Always use this medicine exactly as your doctor has told you. Check with your doctor or pharmacist if you are not sure.

Using this medicine

- Bemfola is intended to be given by injection just under the skin (subcutaneously). Use each pre-filled pen only once then they should be disposed of in a safe manner. Do not administered the solution if it contains particles or is not clear.
- The first injection of Bemfola should be given under supervision of your doctor.
- Your doctor or nurse will show you how to use the Bemfola pre-filled pen to inject the medicine yourself.
- If you administer Bemfola to yourself, please carefully read and follow the “Instructions for Use”. These instructions can be found at the end of the package leaflet.

How much to use

Your doctor will decide how much medicine you will take and how often. The doses described below are stated in International Units (IU) and millilitres (mL).

Women

If you are not ovulating and have irregular or no periods

- Bemfola is usually given every day.
- If you have irregular periods, start using Bemfola within the first 7 days of your menstrual cycle. If you do not have periods you can start using the medicine on any convenient day.

- The usual starting dose of Bemfola is 75 to 150 IU (0.12 to 0.25 mL) each day.
- Your dose of Bemfola may be increased every 7 or every 14 days by 37.5 to 75 IU, until you get the desired response.
- The maximum daily dose of Bemfola is usually not higher than 225 IU (0.375 mL).
- When you get the desired response, you will be given a single injection of 250 micrograms of “recombinant hCG” (r-hCG, an hCG made in a laboratory by a special DNA technique), or 5 000 to 10 000 IU of hCG, 24 to 48 hours after your last Bemfola injection. The best time to have sex is on the day of the hCG injection and the day after.

If your doctor cannot see a desired response after 4 weeks, that treatment cycle with Bemfola should be stopped. For the following treatment cycle, your doctor will give you a higher starting dose of Bemfola than before.

If your body responds too strongly, your treatment will be stopped and you will not be given any hCG (see section 2, “Ovarian hyper-stimulation syndrome (OHSS)”). For the following cycle, your doctor will give you a lower dose of Bemfola than before.

If you have been diagnosed with very low levels of FSH and LH hormones

- The usual starting dose of Bemfola is 75 to 150 IU (0.12 to 0.25 mL) together with 75 IU (0.12 mL) of lutropin alfa.
- You will use these two medicines each day for up to five weeks.
- Your dose of Bemfola may be increased every 7 or every 14 days by 37.5 to 75 IU, until you get the desired response.
- When you get the desired response, you will be given a single injection of 250 micrograms of “recombinant hCG” (r-hCG, an hCG made in a laboratory by a special DNA technique), or 5,000 to 10,000 IU of hCG, 24 to 48 hours after your last injections of Bemfola and lutropin alfa. The best time to have sex is on the day of the hCG injection and the day after. Alternatively, intrauterine insemination or another medically assisted reproduction procedure may be performed based on your doctor’s judgment.

If your doctor cannot see a response after 5 weeks, that treatment cycle with Bemfola should be stopped. For the following cycle, your doctor will give you a higher starting dose of Bemfola than before.

If your body responds too strongly, your treatment with Bemfola will be stopped and you will not be given any hCG (see section 2, “Ovarian hyper-stimulation syndrome (OHSS)”). For the following cycle, your doctor will give you a lower dose of Bemfola than before.

If you need to develop several eggs for collection prior to any assisted reproductive technology

- The usual starting dose of Bemfola is 150 to 225 IU (0.25 to 0.37 mL) each day, from day 2 or 3 of your treatment cycle.
- Bemfola dose may be increased, depending on your response. The maximum daily dose is 450 IU (0.75 mL).
- Treatment is continued until your eggs have developed to a desired point. This usually takes about 10 days but can take any time between 5 and 20 days. Your doctor will use blood tests and/or an ultrasound machine to check when this is.
- When your eggs are ready, you will be given a single injection of 250 micrograms “recombinant hCG” (r-hCG, an hCG made in a laboratory by a special recombinant DNA technique), or 5 000 IU to 10 000 IU of hCG, 24 to 48 hours after the last Bemfola injection. This gets your eggs ready for collection.

In other cases, your doctor may first stop you from ovulating by using a gonadotropin-releasing hormone (GnRH) agonist or antagonist. Then Bemfola is started approximately two weeks after start of agonist treatment. The Bemfola and GnRH agonist are then both given until your follicles develop as desired. For example, after two weeks of GnRH agonist treatment, 150 to 225 IU Bemfola is administered for 7 days. The dose is then adjusted according to your ovarian response.

Men

- The usual dose of Bemfola is 150 IU (0.25 mL) together with hCG.
- You will use these two medicines three times a week for at least 4 months.
- If you have not responded to treatment after 4 months, your doctor may suggest that you continue using these two medicines for at least 18 months.

If you use more Bemfola than you should

The effects of taking too much Bemfola are unknown. Nevertheless, one could expect ovarian hyper-stimulation syndrome (OHSS) to occur, which is described in section 4. However, the OHSS will only occur if hCG is also administered (see section 2, “Ovarian hyper-stimulation syndrome (OHSS)”).

If you forget to use Bemfola

If you forget to use Bemfola, do not take a double dose to make up for a forgotten dose. Please talk to your doctor as soon as you notice that you forgot a dose.

If you have any further questions on the use of this medicine, ask your doctor or pharmacist.

4. Possible side effects

Like all medicines, this medicine can cause side effects, although not everybody gets them.

Serious side effects in women

- Lower abdominal pain together with nausea or vomiting may be the symptoms of ovarian hyper-stimulation syndrome (OHSS). This may indicate that the ovaries over-reacted to the treatment and that large ovarian cysts developed (see also section 2 “Ovarian hyper-stimulation syndrome (OHSS)”). This side effect is common (may affect up to 1 in 10 people).
- The OHSS may become severe with clearly enlarged ovaries, decreased urine production, weight gain, difficulty in breathing and/or possible fluid accumulation in your stomach or chest. This side effect is uncommon (may affect up to 1 in 100 people).
- Complications of OHSS such as twisting of ovaries or blood clotting may occur rarely (may affect up to 1 in 1 000 people).
- Serious blood clotting complications (thromboembolic events) sometimes independent of OHSS may be found very rarely (may affect up to 1 in 10 000 people). This could cause chest pain, breathlessness, stroke or heart attack (see also section 2 “Blood clotting problems (thromboembolic events)”).

Serious side effects in men and women

- Allergic reactions such as rash, red skin, hives, swelling of your face with difficulty breathing can sometimes be serious. This side effect is very rare (may affect up to 1 in 10 000 people).

If you notice any of the above-listed side effects you should immediately contact your doctor, who might ask you to stop using Bemfola.

Other side effects in women

Very common (may affect more than 1 in 10 people):

- Sacs of fluid within the ovaries (ovarian cysts)
- Headache
- Local reactions at the injection site, such as pain, redness, bruising, swelling and/or irritation

Common (may affect up to 1 in 10 people):

- Abdominal pain
- Feeling sick, vomiting, diarrhoea, abdominal cramps and bloating

Very rare (may affect up to 1 in 10 000 people):

- Allergic reactions such as rash, red skin, hives, swelling of your face with difficulty breathing may occur. These reactions can sometimes be serious.
- Your asthma may get worse.

Other side effects in men

Very common (may affect more than 1 in 10 people):

- Local reactions at the injection site, such as pain, redness, bruising, swelling and/or irritation

Common (may affect up to 1 in 10 people):

- Swelling of the veins above and behind the testicles (varicocele)
- Breast development, acne or weight gain

Very rare (may affect up to 1 in 10 000 people):

- Allergic reactions such as rash, red skin, hives, swelling of your face with difficulty in breathing may occur. These reactions can sometimes be serious.
- Your asthma may get worse.

Reporting of side effects

If you get any side effects, talk to your doctor or pharmacist. This includes any possible side effects not listed in this leaflet. You can also report side effects directly via Yellow Card Scheme, Website: www.mhra.gov.uk/yellowcard or search for MHRA Yellow Card in the Google Play or Apple App Store. By reporting side effects you can help provide more information on the safety of this medicine.

5. How to store Bemfola

Keep this medicine out of the sight and reach of children.

Do not use this medicine after the expiry date, which is stated on the pen label and carton after EXP. The expiry date refers to the last day of that month.

Store in a refrigerator (2°C - 8°C). Do not freeze.
Store in the original package in order to protect from light.

Within its shelf life, the unopened pen may be stored at or below 25°C for up to 3 months without being refrigerated again and must be discarded if it has not been used after 3 months.

Do not use this medicine if you notice any visible signs of deterioration, if the liquid contains particles or is not clear.

Once opened, the medicine should be injected immediately.

Do not throw any medicines away via wastewater or household waste. Ask your pharmacist how to dispose of medicines you no longer use. These measures will help protect the environment.

6. Contents of the pack and other information

What Bemfola contains

- The active substance is follitropin alfa.
- Bemfola 75 IU/0.125 mL: Each cartridge contains 75 IU (equivalent to 5.5 micrograms) follitropin alfa in 0.125 mL solution.
- Bemfola 150 IU/0.25 mL: Each cartridge contains 150 IU (equivalent to 11 micrograms)

- follitropin alfa in 0.25 mL solution.
- Bemfola 225 IU/0.375 mL: Each cartridge contains 225 IU (equivalent to 16.5 micrograms) follitropin alfa in 0.375 mL solution.
- Bemfola 300 IU/0.50 mL: Each cartridge contains 300 IU (equivalent to 22 micrograms) follitropin alfa in 0.50 mL solution.
- Bemfola 450 IU/0.75 mL: Each cartridge contains 450 IU (equivalent to 33 micrograms) follitropin alfa in 0.75 mL solution.

- Each mL of the solution contains 600 IU (equivalent to 44 micrograms) follitropin alfa.

- The other ingredients are poloxamer 188, sucrose, methionine, disodium phosphate dihydrate, sodium dihydrogen phosphate dihydrate, phosphoric acid and water for injections.

What Bemfola looks like and contents of the pack

- Bemfola is presented as a clear, colourless liquid for injection in a pre-filled pen (injection).
- Bemfola is supplied in packs with 1, 5 or 10 pre-filled pens, 1, 5 or 10 disposable needles and 1, 5 or 10 alcohol swabs. Not all pack sizes may be marketed.

Marketing Authorisation Holder and Manufacturer

Gedeon Richter Plc.
Gyömrői út 19-21.
1103 Budapest
Hungary

This leaflet was last revised in December 2022

Bemfola 75 IU/0.125 mL pre-filled pen
Bemfola 150 IU/0.25 mL pre-filled pen
Bemfola 225 IU/0.375 mL pre-filled pen
Bemfola 300 IU/0.50 mL pre-filled pen
Bemfola 450 IU/0.75 mL pre-filled pen

Instructions for Use

CONTENTS

1. How to use the Bemfola pre-filled pen
2. Before you start using your pre-filled pen
3. Getting your pre-filled pen ready for injection
4. Setting the dose prescribed by your doctor
5. Injecting the dose
6. After the injection

<p>Warning: Please read and follow this Instructions for Use of Bemfola pre-filled pen. Do not follow instructions from other sources than those provided in this Instructions for Use or by your health care professional as it may compromise the proper use of the pre-filled pen and your treatment.</p>

1. How to use the Bemfola pre-filled pen

- Before starting to use your pre-filled pens, please read the full Instructions for Use and the package leaflet carefully.
- Each pre-filled pen is only for your **single use** – do not let anyone else use it.
- The numbers on the dose display of the pre-filled pens are measured in International Units or IU. **Your doctor will have told you how many IU to inject each day.**
- **Your doctor/pharmacist will tell you how many pre-filled Bemfola pens for single use you need to use for your complete treatment course.**
- Give yourself the injection around the same time each day.

2. Before you start using your pre-filled pen

2.1. Take the pen out of the fridge

- Take one of your pens out of the fridge 5 to 10 minutes before using it.
- If the medicine is frozen, then please **do not** use it.

2.2. Wash your hands

- Wash your hands with soap and warm water, and dry them.
- It is important that your hands and the things you use to get your pen ready are as clean as possible.

2.3. Find a clean area

- A good place is a clean table or surface.

3. Getting your pre-filled pen ready for injection

The different parts of your pre-filled pen

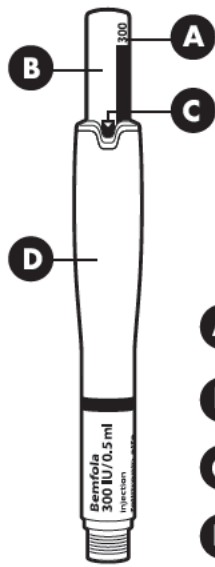

- A** Dosage
- B** Dosage knob
- C** Activation bar
- D** Cartridge with medication
- E** Needle
- F** Inner needle cap
- G** Outer needle cap

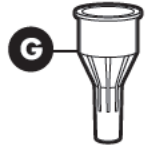
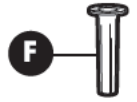

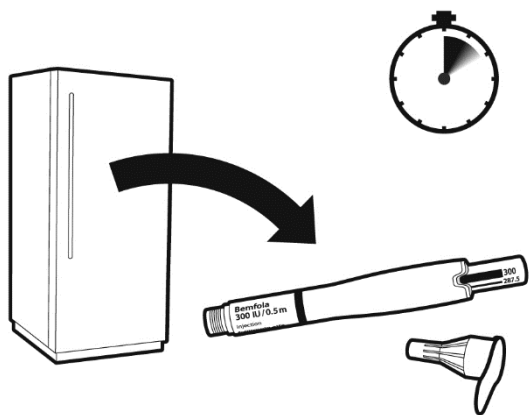

Perform the injection every day around the same time. Take the pen out of the fridge 5 to 10 minutes before using it.

Note: Please check that the medicine is not frozen.

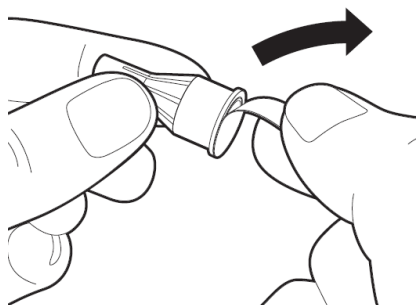

Prepare your needle for injection

Get a new needle - only use the single-use needles supplied in the package. Hold the outer needle cap firmly.

Check in all cases that the peel-off seal on the outer needle cap is not damaged or loose.

Remove the peel-off seal from the injection needle.

***Caution:** If the peel-off seal is damaged or loose, do not use the needle. Throw it away in a sharps disposal container. Get a new needle.*

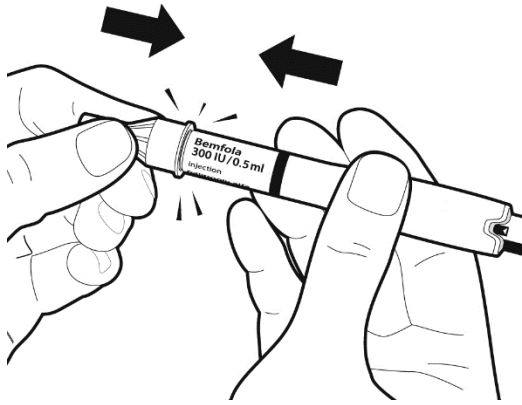

Attach the needle.

Hold the pen by its sides and keep the needle in line with it while attaching the needle and firmly snap the needle on to the tip of the pen. Make sure that the needle is properly secured on the pen in a straight position.

Caution: Despite the fact that there is a thread at the end of the pen, **never try to twist the needle to the pen**, as this may lead to the incorrect positioning of the needle. Do not push the dosage knob in while attaching the needle.

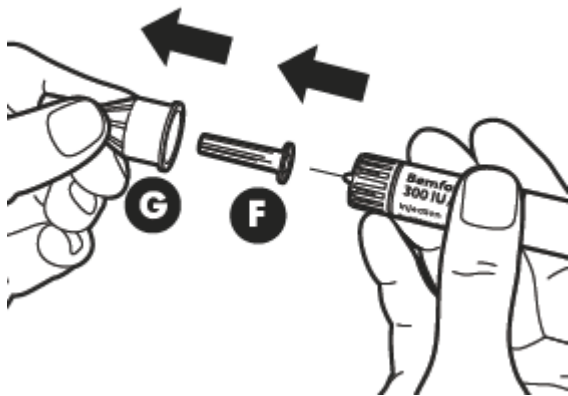

Remove the outer needle cap (G). **Keep it for later. You will need it after the injection to discard the pen.**

Remove the inner needle cap (F).

Make sure that the needle is in the correct position.

Correct position of the needle

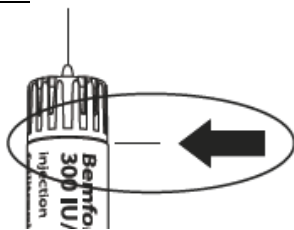

Incorrect position of the needle

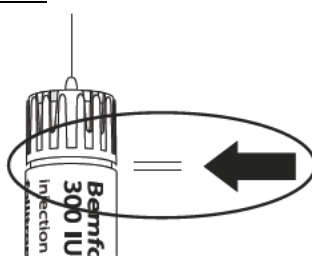

4. Setting the dose prescribed by your doctor

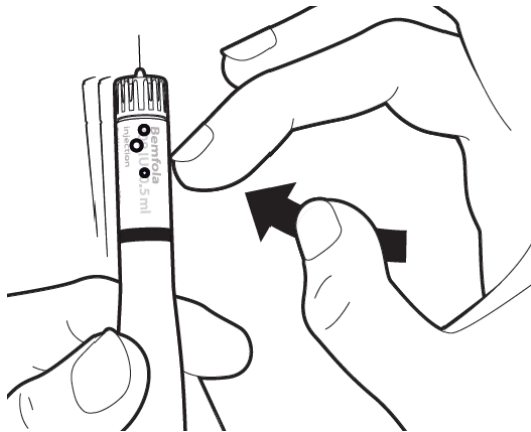

First, hold the pen so that the needle is pointing upwards. To remove the air bubbles from the system, gently tap the side of the pen to make the existing air bubbles rise to the top.

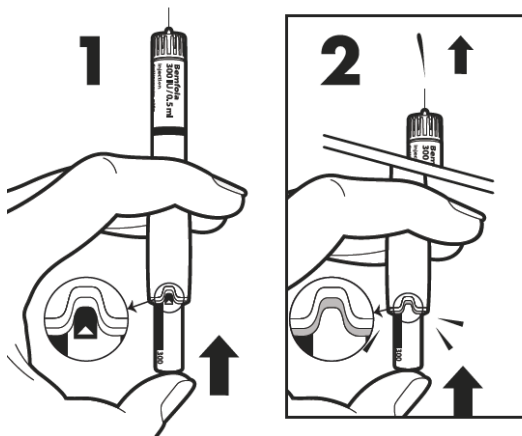

Still holding the pen upright, push the **dosage knob** in until the **activation bar** with the small arrow disappears. You should also hear a click, and some liquid will splash out (this is normal). The pen is now ready to set the dose.

Caution: If no liquid splashes out, or liquid leakage is detected at the junction of the needle and the pen, the pen should not be used. Tell your doctor or pharmacist if you notice any problems.

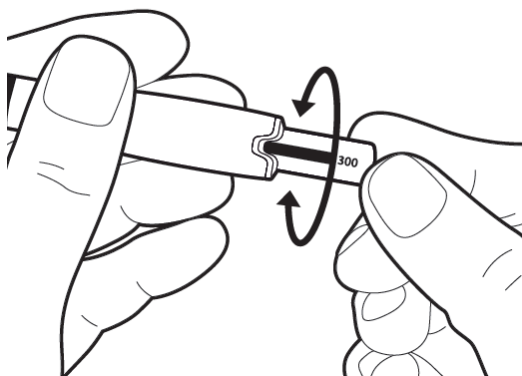

Gently turn the dosage knob until the bar of your prescribed dose is in line with the middle of the indent on the pen.

Note: For the Bemfola 75 IU/0.125 mL pre-filled pen, the dosage knob cannot go around completely, but it can still be rotated backwards.

The pen is now ready for injection.

Caution: Do not push the dosage knob in any further, at this point.

5. Injecting the dose

Now you are ready to immediately give yourself the injection: Your doctor or nurse will have already advised you where to inject (e.g. tummy, front of thigh). To minimise skin irritation, select a different injection site each day.

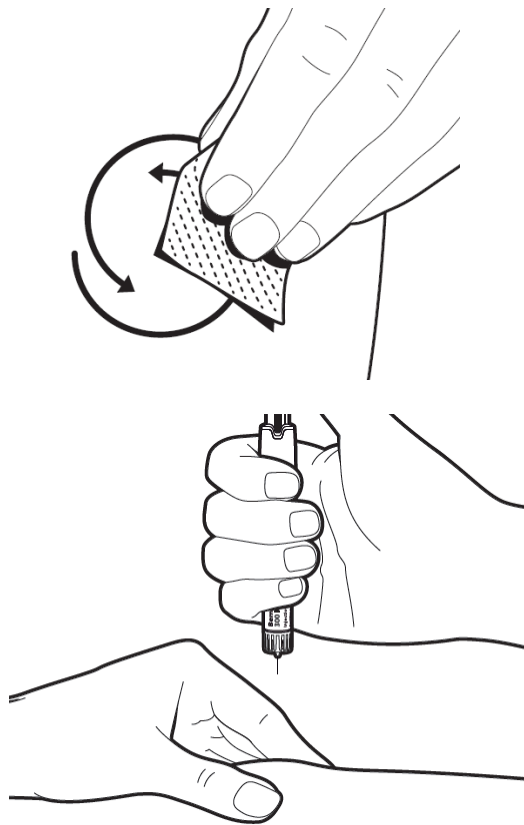

Clean the injection site with the alcohol swab available in the package, using a circular motion. Wait for a few seconds until the alcohol has evaporated from the skin and it is dry before injecting.

Check again that the correct dose is displayed on the pen. Lightly pinch the skin of the injection area. Hold the pen at approximately a right angle (90° angle) and insert the needle completely in one steady movement into your skin.

Caution: Do not push the dosage knob, while inserting the needle and do not change the direction of the needle as it goes in.

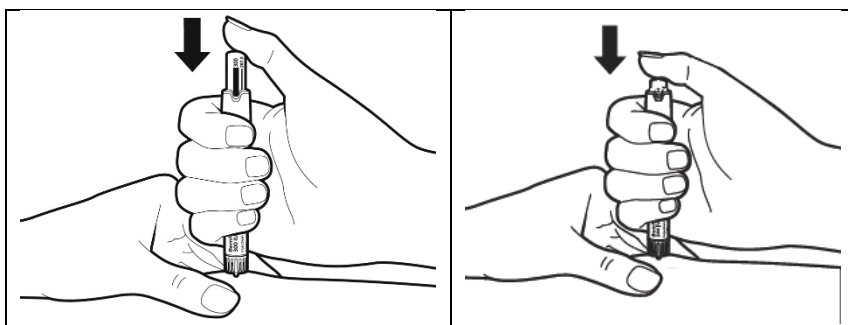

Once the needle is fully inserted in the injection site, push in the dosage knob slowly and continuously until it stops, and the bar of the set dose has disappeared. Do not remove the needle immediately, wait at least for **5 seconds**, before pulling it out to ensure you have injected the full dose.

After the withdrawal of the needle: clean the skin with an alcohol swab using a circular motion at the injection site.

Caution: If liquid leakage is detected at the junction of the needle and the pen during injecting, tell your doctor or pharmacist.

6. After the injection

Replace the outer needle cap onto the needle carefully.

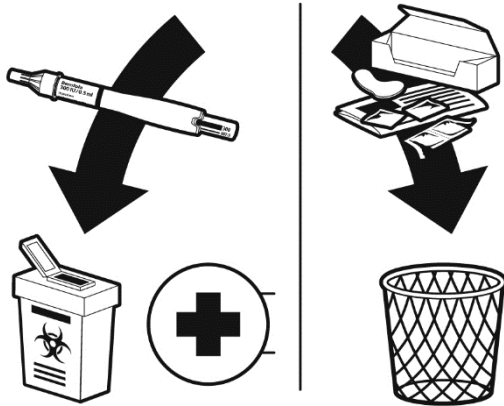
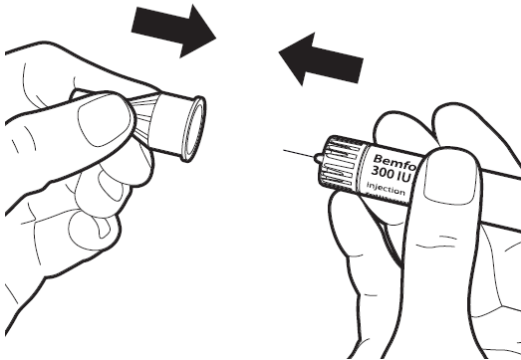

You can use the pre-filled injection pen only once and must discard the pen even if any liquid remains in the pen after injection.

Throw away the packaging box, inner needle cap, peel tab, alcohol swab and the Instructions for Use in the normal household waste. Do not throw away any medicines via your sink, toilet or in your household waste. The used pen needs to be discarded in a sharps container and returned to the pharmacy for a correct disposal. Ask your pharmacist how to dispose of medicines you no longer use.