

Package leaflet: Information for the user

Xolair® 75 mg solution for injection in pre-filled syringe (pre-filled syringe with 26-gauge staked needle, blue syringe guard) omalizumab

Read all of this leaflet carefully before you start using this medicine because it contains important information for you.

- Keep this leaflet. You may need to read it again.
- If you have any further questions, ask your doctor, pharmacist or nurse.
- This medicine has been prescribed for you only. Do not pass it on to others. It may harm them, even if their signs of illness are the same as yours.
- If you get any side effects, talk to your doctor, pharmacist or nurse. This includes any possible side effects not listed in this leaflet. See section 4.

What is in this leaflet

1. What Xolair is and what it is used for
2. What you need to know before you use Xolair
3. How to use Xolair
4. Possible side effects
5. How to store Xolair
6. Contents of the pack and other information

1. What Xolair is and what it is used for

Xolair contains the active substance omalizumab. Omalizumab is a man-made protein that is similar to natural proteins produced by the body. It belongs to a class of medicines called monoclonal antibodies. Xolair is used for the treatment of:

- allergic asthma
- chronic rhinosinusitis (inflammation of the nose and sinuses) with nasal polyps

Allergic asthma

This medicine is used to prevent asthma from getting worse by controlling symptoms of severe allergic asthma in adults, adolescents and children (6 years of age and older) who are already receiving asthma medicine, but whose asthma symptoms are not well controlled by medicines such as high-dose steroid inhalers and beta-agonist inhalers.

Chronic rhinosinusitis with nasal polyps

This medicine is used to treat chronic rhinosinusitis with nasal polyps in adults (18 years of age and older) who are already receiving intranasal corticosteroids (corticosteroid nasal spray), but whose symptoms are not well controlled by these medicines. Nasal polyps are small growths on the lining of the nose. Xolair helps to reduce the size of the polyps and improves symptoms including nasal congestion, loss of sense of smell, mucus in the back of the throat and runny nose.

Xolair works by blocking a substance called immunoglobulin E (IgE), which is produced by the body. IgE contributes to a type of inflammation that plays a key role in causing allergic asthma and chronic rhinosinusitis with nasal polyps.

2. What you need to know before you use Xolair

Do not use Xolair:

- if you are allergic to omalizumab or any of the other ingredients of this medicine (listed in section 6).

If you think you may be allergic to any of the ingredients, tell your doctor as you should not use Xolair.

Warnings and precautions

Talk to your doctor before using Xolair:

- if you have kidney or liver problems.
- if you have a disorder where your own immune system attacks parts of your own body (autoimmune disease).
- if you are travelling to region where infections caused by parasites are common - Xolair may weaken your resistance to such infections.
- if you have had a previous severe allergic reaction (anaphylaxis), for example resulting from a medicine, an insect bite or food.
- if you have ever had an allergic reaction to latex. The needle cap of the syringe may contain dry rubber (latex).

Xolair does not treat acute asthma symptoms, such as a sudden asthma attack. Therefore Xolair should not be used to treat such symptoms.

Xolair is not meant to prevent or treat other allergy-type conditions, such as sudden allergic reactions, hyperimmunoglobulin E syndrome (an inherited immune disorder), aspergillosis (a fungus-related lung disease), food allergy, eczema or hay fever because Xolair has not been studied in these conditions.

Look out for signs of allergic reactions and other serious side effects

Xolair can potentially cause serious side effects. You must look out for signs of these conditions while you use Xolair. Seek medical help immediately if you notice any signs indicating a severe allergic reaction or other serious side effects. Such signs are listed under “Serious side effects” in section 4.

It is important that you receive training from your doctor in how to recognise early symptoms of severe allergic reactions, and how to manage these reactions if they occur, before you inject Xolair yourself or before a non-healthcare professional gives you a Xolair injection (see section 3, “How to use Xolair”). The majority of severe allergic reactions occur within the first 3 doses of Xolair.

Children and adolescents

Allergic asthma

Xolair is not recommended for children under 6 years of age. Its use in children under 6 years of age has not been studied.

Chronic rhinosinusitis with nasal polyps

Xolair is not recommended for children and adolescents under 18 years of age. Its use in patients under 18 years of age has not been studied.

Other medicines and Xolair

Tell your doctor, pharmacist or nurse if you are taking, have recently taken or might take any other medicines.

This is especially important if you are taking:

- medicines to treat an infection caused by a parasite, as Xolair may reduce the effect of your medicines,
- inhaled corticosteroids and other medicines for allergic asthma.

Pregnancy and breast-feeding

If you are pregnant, think you may be pregnant or are planning to have a baby, ask your doctor for advice before using this medicine. Your doctor will discuss with you the benefits and potential risks of using this medicine during pregnancy.

If you become pregnant while being treated with Xolair, tell your doctor immediately.

Xolair may pass into breast milk. If you are breast-feeding or plan to breast-feed, ask your doctor for

advice before using this medicine.

Driving and using machines

It is unlikely that Xolair will affect your ability to drive and use machines.

3. How to use Xolair

Always use this medicine exactly as your doctor has told you. Check with your doctor, nurse or pharmacist if you are not sure.

How Xolair is used

Xolair is used as an injection under your skin (known as a subcutaneous injection).

Injecting Xolair

- You and your doctor will decide if you should inject Xolair yourself. The first 3 doses are always given by or under the supervision of a healthcare professional (see section 2).
- It is important to be properly trained on how to inject the medicine before injecting yourself.
- A caregiver (for example a parent) may also give you your Xolair injection after he or she has received proper training.

For detailed instructions on how to inject Xolair, see “Instructions for use of Xolair pre-filled syringe” at the end of this leaflet.

Training to recognise serious allergic reactions

It is also important that you do not inject Xolair yourself until you have been trained by your doctor or nurse on:

- how to recognise the early signs and symptoms of serious allergic reactions.
- what to do if the symptoms occur.

For more information about the early signs and symptoms of serious allergic reactions, see section 4.

How much to use

Your doctor will decide how much Xolair you need and how often you will need it. This depends on your body weight and the results of a blood test carried out before the start of the treatment to measure the amount of IgE in your blood.

You will need 1 to 4 injections at a time. You will need the injections either every two weeks, or every four weeks.

Keep taking your current asthma and/or nasal polyps medicine during Xolair treatment. Do not stop taking any asthma and/or nasal polyps medicine without talking to your doctor.

You may not see an immediate improvement after beginning Xolair treatment. In patients with nasal polyps effects have been seen 4 weeks after the start of the treatment. In asthma patients it usually takes between 12 and 16 weeks to have the full effect.

Use in children and adolescents

Allergic asthma

Xolair can be used in children and adolescents aged 6 years and older, who are already receiving asthma medicine, but whose asthma symptoms are not well controlled by medicines such as high dose steroid inhalers and beta-agonist inhalers. Your doctor will work out how much Xolair your child needs and how often it needs to be given. This will depend on your child’s weight and the results of a blood test carried out before the start of the treatment to measure the amount of IgE in his/her blood.

Children (6 to 11 years of age) are not expected to self-administer Xolair. However, if considered

appropriate by their doctor, a caregiver may give them their Xolair injection after proper training.

Chronic rhinosinusitis with nasal polyps

Xolair should not be used in children and adolescents under 18 years of age.

If a dose of Xolair is missed

If you have missed an appointment, contact your doctor or hospital as soon as possible to re-schedule it.

If you have forgotten to give yourself a dose of Xolair, inject the dose as soon as you remember. Then talk to your doctor to discuss when you should inject the next dose.

If you stop treatment with Xolair

Do not stop treatment with Xolair unless your doctor tells you to. Interrupting or stopping the treatment with Xolair may cause your symptoms to come back.

If you have any further questions on the use of this medicine, ask your doctor, pharmacist or nurse.

4. Possible side effects

Like all medicines, this medicine can cause side effects, although not everybody gets them. The side effects caused by Xolair are usually mild to moderate but can occasionally be serious.

Serious side effects:

Seek medical attention immediately if you notice any signs of the following side effects:

Rare (may affect up to 1 in 1 000 people)

- Severe allergic reactions (including anaphylaxis). Symptoms may include rash, itching or hives on the skin, swelling of the face, lips, tongue, larynx (voice box), windpipe or other parts of the body, fast heartbeat, dizziness and light-headedness, confusion, shortness of breath, wheezing or trouble breathing, blue skin or lips, collapsing and losing consciousness. If you have a history of severe allergic reactions (anaphylaxis) unrelated to Xolair you may be more at risk of developing a severe allergic reaction following use of Xolair.
- Systemic lupus erythematosus (SLE). Symptoms may include muscle pain, joint pain and swelling, rash, fever, weight loss, and fatigue.

Not known (frequency cannot be estimated from the available data)

- Churg-Strauss syndrome or hypereosinophilic syndrome. Symptoms may include one or more of the following: swelling, pain or rash around blood or lymph vessels, high level of a specific type of white blood cells (marked eosinophilia), worsening problems with breathing, nasal congestion, heart problems, pain, numbness, tingling in the arms and legs.
- Low blood platelet count with symptoms such as bleeding or bruising more easily than normal.
- Serum sickness. Symptoms may include one or more of the following: joint pain with or without swelling or stiffness, rash, fever, swollen lymph nodes, muscle pain.

Other side effects include:

Very common (may affect more than 1 in 10 people)

- fever (in children)

Common (may affect up to 1 in 10 people)

- reactions at the injection site including pain, swelling, itching and redness
- pain in the upper part of the tummy
- headache (very common in children)
- feeling dizzy
- pain in joints (arthralgia)

Uncommon (may affect up to 1 in 100 people)

- feeling sleepy or tired
- tingling or numbness of the hands or feet
- fainting, low blood pressure while sitting or standing (postural hypotension), flushing
- sore throat, coughing, acute breathing problems
- feeling sick (nausea), diarrhoea, indigestion
- itching, hives, rash, increased sensitivity of the skin to sun
- weight increase
- flu-like symptoms
- swelling arms

Rare (may affect up to 1 in 1 000 people)

- parasitic infection

Not known (frequency cannot be estimated from the available data)

- muscle pain and joint swelling
- hair loss

Reporting of side effects

If you get any side effects, talk to your doctor, pharmacist or nurse. This includes any possible side effects not listed in this leaflet. You can also report side effects directly via the Yellow Card Scheme at: www.mhra.gov.uk/yellowcard or search for MHRA Yellow Card in the Google Play or Apple App Store. By reporting side effects you can help provide more information on the safety of this medicine.

5. How to store Xolair

- Keep this medicine out of the sight and reach of children.
- Do not use this medicine after the expiry date which is stated on the label after EXP. The expiry date refers to the last day of that month. The carton containing the pre-filled syringe can be stored for a total time of 48 hours at room temperature (25°C) before use.
- Store in the original package in order to protect from light.
- Store in a refrigerator (2°C – 8°C). Do not freeze.
- Do not use any pack that is damaged or shows signs of tampering.

6. Contents of the pack and other information

What Xolair contains

- The active substance is omalizumab. One syringe of 0.5 ml solution contains 75 mg omalizumab.
- The other ingredients are arginine hydrochloride, histidine hydrochloride monohydrate, histidine, Polysorbate 20 and water for injections.
- The needle cap of the syringe may contain dry rubber (latex).

What Xolair looks like and contents of the pack

Xolair solution for injection is supplied as a clear to slightly opalescent, colourless to pale brownish-yellow solution in a pre-filled syringe.

Xolair 75 mg solution for injection in pre-filled syringe with 26-gauge staked needle and blue syringe guard is available in packs containing 1 pre-filled syringe and in multipacks containing 4 (4 x 1) or 10 (10 x 1) pre-filled syringes.

Not all pack sizes may be marketed.

Marketing Authorisation Holder and Manufacturer

Novartis Pharmaceuticals UK Limited

2nd Floor, The WestWorks Building, White City Place
195 Wood Lane
London
W12 7FQ
United Kingdom

For any information about this medicine, please contact the local representative of the Marketing Authorisation Holder:

United Kingdom

Novartis Pharmaceuticals UK Ltd.

Tel: +44 1276 698370

This leaflet was last revised in September 2023.

INSTRUCTIONS FOR USE OF XOLAIR PRE-FILLED SYRINGE

Read ALL the way through these instructions before injecting. If your doctor decides that you or a caregiver may be able to give your injections of Xolair at home, you need to be trained by your doctor, nurse or pharmacist before you inject yourself or others. Children (6 to less than 12 years of age) are not expected to inject Xolair themselves, however, if deemed appropriate by their doctor, a caregiver may give them their Xolair injection after proper training. The box contains Xolair pre-filled syringe(s) individually sealed in a plastic tray.

Your Xolair 75 mg solution for injection in pre-filled syringe

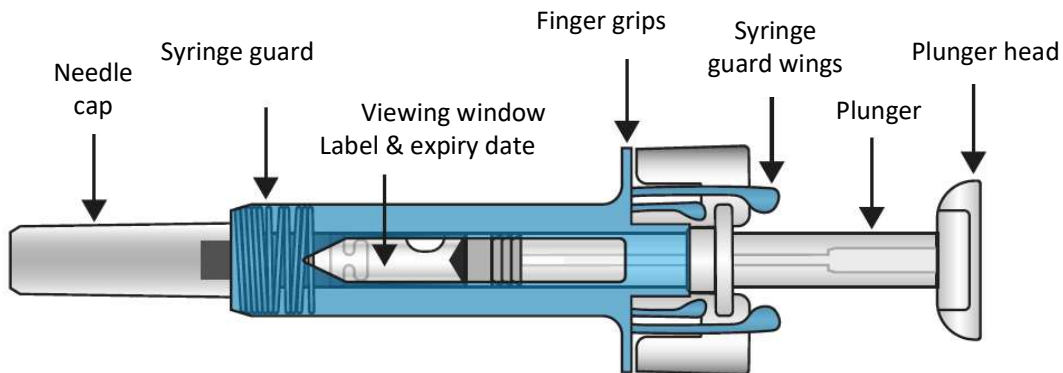

After the medicine has been injected, the syringe guard will be activated to cover the needle. This is intended to protect against accidental needlestick injuries.

Other items you need for your injection:

- Alcohol swab.
- Cotton ball or gauze.
- Sharps disposal container.

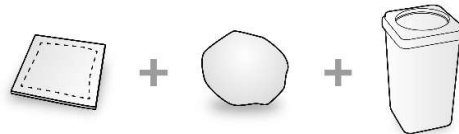

Important safety information

Caution: Keep the syringe out of the sight and reach of children.

- The needle cap of the syringe may contain dry rubber (latex), which should not be handled by anyone who is sensitive to this substance.
- Do not open the sealed outer box until you are ready to use this medicine.
- Do not use this medicine if either the seal on the outer box or the seal of the plastic tray is broken, as it may not be safe for you to use.
- Do not use if the syringe has been dropped onto a hard surface or dropped after removing the needle cap.
- Never leave the syringe where others might tamper with it.
- Do not shake the syringe.
- Be careful not to touch the syringe guard wings before use. If the wings are touched, the syringe guard may be activated too early.
- Do not remove the needle cap until just before you give the injection.
- The syringe cannot be re-used. Dispose of the used syringe immediately after use in a sharps container.

Storage of Xolair solution for injection in pre-filled syringe

- Store this medicine sealed in its outer box to protect it from light. Store in the refrigerator

between 2°C and 8°C. DO NOT FREEZE.

- Remember to take the syringe out of the refrigerator and allow it to reach room temperature (25°C) before preparing it for injection (it will take about 30 minutes). Leave the syringe in the box to protect it from light. The total time that the syringe is kept at room temperature (25°C) before use must not exceed 48 hours.
- Do not use the syringe after the expiry date which is stated on the outer box and syringe label. If it has expired, return the entire pack to the pharmacy.

The injection site

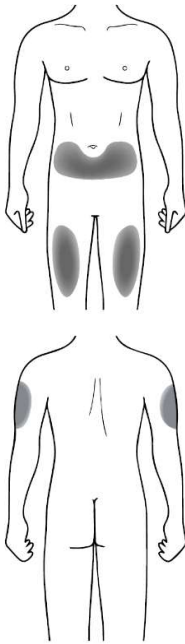









The injection site is the place on the body where you are going to use the syringe.

- The recommended site is the front of the thighs. You may also use the lower abdomen, but **not** the area 5 centimetres around the navel (belly button).
- If you need to give more than one injection for the full dose, choose a different injection site each time you inject.
- Do not inject into areas where the skin is tender, bruised, red, or hard. Avoid areas with scars or stretch marks.

If a caregiver is giving the injection, the outer upper arms may also be used.

Preparing Xolair solution for injection in pre-filled syringe for use

Note: Depending on the dose prescribed to you by your doctor, you may need to prepare one or more pre-filled syringes, and inject the contents of them all. The following table gives examples of how many injections of each dose strength you need for a given dose:

Dose	Syringes needed for the dose	
75 mg	1 blue (75 mg)	
150 mg	1 purple (150 mg)	
225 mg	1 blue (75 mg) + 1 purple (150 mg)	
300 mg	2 purple (150 mg)	
375 mg	1 blue (75 mg) + 2 purple (150 mg)	
450 mg	3 purple (150 mg)	
525 mg	1 blue (75 mg) + 3 purple (150 mg)	
600 mg	4 purple (150 mg)	

1. Take the box containing the syringe out of the refrigerator and leave it **unopened** for about 30 minutes so that it reaches room temperature (leave the syringe in the box to protect it from light).
2. When you are ready to use the syringe, wash your hands thoroughly with soap and water.
3. Clean the injection site with an alcohol swab.
4. Remove the plastic tray from the box, peel back the paper cover. Gripping the middle of the blue syringe guard, lift the syringe out of the tray.
5. Inspect the syringe. The liquid should be clear to slightly cloudy. Its colour may vary from colourless to pale brownish-yellow. You may see an air bubble, which is normal. **DO NOT USE** if the syringe is broken or if the liquid looks distinctly cloudy or distinctly brown, or contains particles. In all these cases, return the entire pack to the pharmacy.
6. Holding the syringe horizontally look into the viewing window to check the expiry date printed on the label. Note: It is possible to rotate the inner part of the syringe assembly so that the label can be read in the viewing window. **DO NOT USE** if the product has expired. If expired, return the entire pack to the pharmacy.

How to use Xolair solution for injection in pre-filled syringe

1

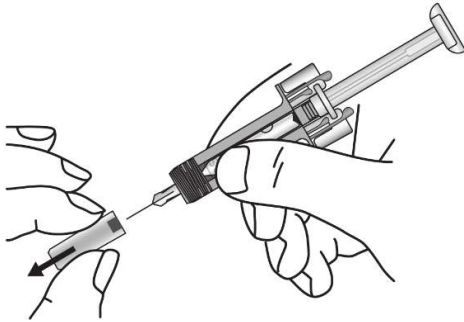

Carefully remove the needle cap from the syringe. Discard the needle cap. You may see a drop of liquid at the end of the needle. This is normal.

2

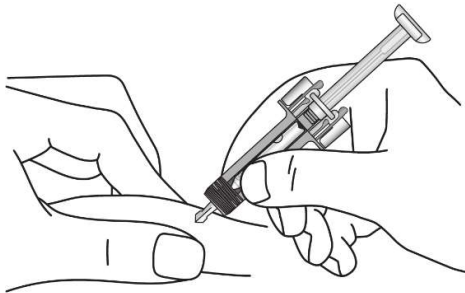

Gently pinch the skin at the injection site and insert the needle as shown. Push the needle all the way in to ensure that the medicine can be fully administered.

3

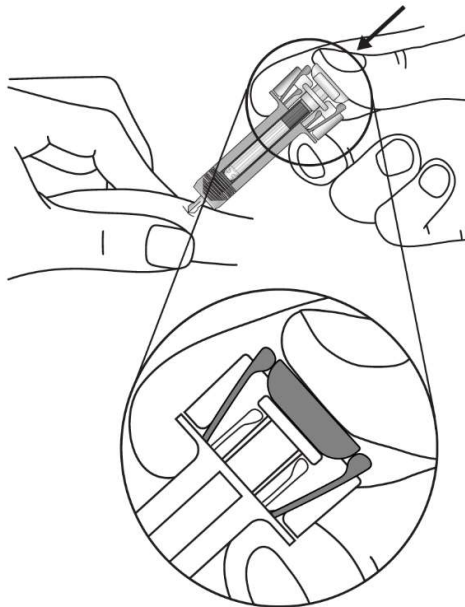

Hold the syringe as shown. **Slowly** depress the plunger **as far as it will go** so that the plunger head is completely between the syringe guard wings.

4

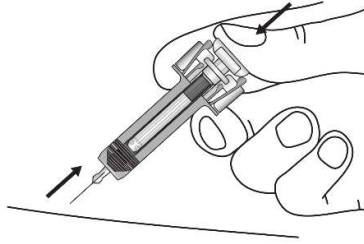

Keep the plunger fully depressed while you carefully lift the needle straight out from the injection site.

5

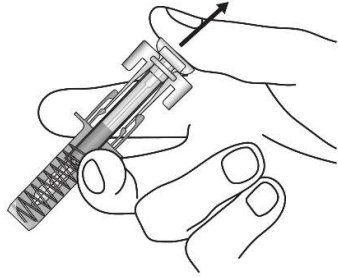

Slowly release the plunger and allow the syringe guard to automatically cover the exposed needle.

There may be a small amount of blood at the injection site. You can press a cotton ball or gauze over the injection site and hold it for 30 seconds. Do not rub the injection site. You may cover the injection site with a small adhesive bandage, if needed.

Disposal instructions



Dispose of the used syringe immediately in a sharps container (closable, puncture resistant container). For the safety and health of you and others, needles and used syringes **must never** be re-used. Any unused medicinal product or waste material should be disposed of in accordance with local requirements. Do not throw away any medicines via wastewater or household waste. Ask your pharmacist how to throw away medicines you no longer use. These measures will help protect the environment.