

PACKAGE LEAFLET: INFORMATION FOR THE USER

GENOTROPIN® 5.3 mg and 12 mg powder and solvent for solution for injection

somatropin

Read all of this leaflet carefully before you start using this medicine because it contains important information for you.

- Keep this leaflet. You may need to read it again.
- If you have any further questions, ask your doctor or pharmacist.
- This medicine has been prescribed for you. Do not pass it on to others. It may harm them, even if their symptoms are the same as yours.
- If any of the side effects gets serious, or if you notice any side effects not listed in this leaflet, please tell your doctor or pharmacist.

What is in this leaflet:

1. What Genotropin is and what it is used for
2. What you need to know before you use Genotropin
3. How to use Genotropin
4. Possible side effects
5. How to store Genotropin
6. Contents of the pack and other information

1. What Genotropin is and what it is used for

Genotropin is a recombinant human growth hormone (also called somatropin). It has the same structure as natural human growth hormone which is needed for bones and muscles to grow. It also helps your fat and muscle tissues to develop in the right amounts. It is recombinant meaning it is not made from human or animal tissue.

In children, Genotropin is used to treat the following growth disturbances:

- If you are not growing properly and you do not have enough of your own growth hormone.
- If you have Turner syndrome. Turner syndrome is a chromosomal error in girls that can affect growth - your doctor will have told you if you have this.
- If you have chronic renal (kidney) insufficiency. As kidneys lose their ability to function normally, this can affect growth.
- If you have Prader-Willi syndrome (a chromosomal disorder). Growth hormone will help you grow taller if you are still growing, and will also improve your body composition. Your excessive fat will decrease and your reduced muscle mass will improve.
- If you were small or too light at birth. Growth hormone can help you grow taller if you have not been able to catch up or maintain normal growth by four years of age or later.

In adults, Genotropin is used to treat persons with pronounced growth hormone deficiency. This can start during adult life, or it can continue from childhood.

If you have been treated with Genotropin for growth hormone deficiency during childhood, your growth hormone status will be retested after completion of growth. If severe growth hormone deficiency is confirmed, your doctor will propose continuation of Genotropin treatment.

You should only be given this medicine by a doctor who has experience with growth hormone treatment and who has confirmed your diagnosis.

2. What you need to know before you use Genotropin

Do not use Genotropin and tell your doctor if

- You are allergic (hypersensitive) to somatotropin or any of the other ingredients of Genotropin.
- You have an active tumour (cancer). Tumours must be inactive and you must have finished your anti-tumour treatment before you start your treatment with Genotropin.
- You are seriously ill (for example, complications following open heart surgery, abdominal surgery, acute respiratory failure, accidental trauma or similar conditions). If you are about to have, or have had, a major operation, or go into hospital for any reason, tell your doctor and remind the other doctors you are seeing that you use growth hormone.
- Genotropin has been prescribed to stimulate growth but you have already stopped growing (closed epiphyses).

Take special care with Genotropin and tell your doctor if any of the following statements apply to you

- If you are at risk of developing diabetes, your doctor will need to monitor your blood sugar level during treatment with Genotropin.
- If you have diabetes, you should closely monitor your blood sugar level during treatment with Genotropin and discuss the results with your doctor to determine whether you need to change the dose of your medicines to treat diabetes.
- After starting Genotropin treatment some patients may need to start thyroid hormone replacement.
- If you are receiving treatment with thyroid hormones it may be necessary to adjust your thyroid hormone dose.
- If you are taking growth hormone to stimulate growth and walk with a limp or if you start to limp during your growth hormone treatment due to pain in your hip, you should inform your doctor.
- If you develop raised intracranial pressure (with symptoms such as strong headache, visual disturbances or vomiting) you should inform your doctor about it.
- If your doctor confirms that you have developed inflammation of the muscles near the injection site because of the preservative metacresol, you should use a Genotropin product without metacresol.
- If you are receiving Genotropin for growth hormone deficiency following a previous tumour (cancer), you should be examined regularly for recurrence of the tumour or any other cancer.
- If you experience worsening abdominal pain you should inform your doctor.
- Experience in patients above 80 years of age is limited. Elderly persons may be more sensitive to the action of Genotropin, and therefore may be more prone to develop side effects.

Children with chronic renal (kidney) insufficiency:

- Your doctor should examine your kidney function and your growth rate before starting Genotropin. Medical treatment for your kidney condition should be continued. Genotropin treatment should be stopped at kidney transplantation.

Children with Prader-Willi syndrome:

- Your doctor will give you diet restrictions to follow to control your weight.
- Your doctor will assess you for signs of upper airway obstruction, sleep apnoea (where your breathing is interrupted during sleep), or respiratory infection before you start treatment with Genotropin.
- During treatment, if you show signs of upper airway obstruction (including starting to snore or worsening of snoring), your doctor will need to examine you and may interrupt your treatment with Genotropin.
- During treatment, your doctor will check you for signs of scoliosis, a type of spinal deformity.
- During treatment, if you develop a lung infection, tell your doctor so that he can treat the infection.

Children born small or too light at birth:

- If you were small or too light at birth and are aged between 9 and 12 years, ask your doctor for specific advice relating to puberty and treatment with this product.

- Your doctor will check your blood sugar and insulin levels before the start of treatment and every year during treatment.
- Treatment should be continued until you have stopped growing.

Using other medicines

Tell your doctor or pharmacist if you are using or have recently used any other medicines, including medicines obtained without a prescription.

Warnings and precautions

Talk to your doctor or pharmacist before using Genotropin.

If you have a replacement therapy with glucocorticoids, you should consult your doctor regularly, as you may need adjustment of your glucocorticoid dose.

You should tell your doctor if you are using:

- medicines to treat diabetes,
- thyroid hormones,
- synthetic adrenal hormones (corticosteroids),
- oestrogen taken orally or other sex hormones,
- ciclosporin (a medicine that weakens the immune system after transplantation),
- medicines to control epilepsy (anticonvulsants).

Your doctor may need to adjust the dose of these medicines or the dose of Genotropin.

Pregnancy and breast-feeding

You should not use Genotropin if you are pregnant, think you may be pregnant or are trying to become pregnant.

Ask your doctor for advice before using this medicine while breast-feeding.

Ask your doctor or pharmacist for advice before taking any medicine.

Genotropin contains sodium

This medicine contains less than 1 mmol sodium (23 mg) per dose, that is to say essentially 'sodium-free'.

3. How to use Genotropin

Recommended dosage

The dose depends on your size, the condition for which you are being treated and how well growth hormone works for you. Everyone is different. Your doctor will advise you about your individualised dose of Genotropin in milligrams (mg) from either your body weight in kilograms (kg) or your body surface area calculated from your height and weight in square metres (m²), as well as your treatment schedule. Do not change the dosage and treatment schedule without consulting your doctor.

Children with growth hormone deficiency:

0.025-0.035 mg/kg body weight per day or 0.7-1.0 mg/m² body surface area per day. Higher doses can be used. When growth hormone deficiency continues into adolescence, Genotropin should be continued until completion of physical development.

Children with Turner syndrome:

0.045-0.050 mg/kg body weight per day or 1.4 mg/m² body surface area per day.

Children with chronic renal (kidney) insufficiency:

0.045-0.050 mg/kg body weight per day or 1.4 mg/m² body surface area per day. Higher doses may be necessary if the rate of growth is too low. Dosage adjustment may be necessary after 6 months of treatment.

Children with Prader-Willi syndrome:

0.035 mg/kg body weight per day or 1.0 mg/m² body surface area per day. The daily dosage should not exceed 2.7 mg. Treatment should not be used in children who have almost stopped growing after puberty.

Children born smaller or lighter than expected and with growth disturbance:

0.035 mg/kg body weight per day or 1.0 mg/m² body surface area per day. It is important to continue treatment until final height is reached. Treatment should be discontinued after the first year if you are not responding or if you have reached your final height and stopped growing.

Adults with growth hormone deficiency:

If you continue Genotropin after treatment during childhood you should start with 0.2-0.5 mg per day. This dosage should be gradually increased or decreased according to blood test results as well as clinical response and side effects.

If your growth hormone deficiency starts during adult life you should start with 0.15-0.3 mg per day. This dosage should be gradually increased according to blood test results as well as clinical response and side effects. The daily maintenance dose seldom exceeds 1.0 mg per day. Women may require higher doses than men. Dosage should be monitored every 6 months. Persons above 60 years should start with a dose of 0.1–0.2 mg per day which should be slowly increased according to individual requirements. The minimum effective dose should be used. The maintenance dose seldom exceeds 0.5 mg per day. Follow the instructions given to you by your doctor.

Injecting Genotropin

Genotropin is intended for subcutaneous use. This means that it is injected through a short injection needle into the fatty tissue just under your skin. Your doctor should have already shown you how to use Genotropin. Always inject Genotropin exactly as your doctor has told you. You should check with your doctor or pharmacist if you are not sure.

The instructions for using the pre-filled pen GoQuick® are provided in the carton with the pre-filled pen.

The instructions for using the Genotropin two-chamber cartridge with the Genotropin Pen or Genotropin Mixer are provided with your devices.

Refer to the instructions for use before using your medicine.

When using a pre-filled pen, a pen injection device or reconstitution device, the needle must be screwed on before mixing. A new needle must be used for each injection. Needles must not be re-used.

- Preparing the injection:

You can take your Genotropin out of the refrigerator half an hour before your injection. This lets it warm up slightly and can make your injections more comfortable.

The GoQuick pre-filled pen contains the two-chamber cartridge that has both the growth hormone and the dissolving liquid in it. The growth hormone and the dissolving liquid are mixed together by twisting the cartridge holder (see the detailed steps in the Instructions for Use). A separate device is not needed.

Genotropin in a two-chamber cartridge contains both the growth hormone and the dissolving liquid and it is to be used in a Genotropin device. The growth hormone and the dissolving liquid in the two-chamber cartridge can be mixed together using a Genotropin Mixer or by screwing the Genotropin Pen device together.

For both the GoQuick pre-filled pen and the two-chamber cartridge, dissolve the powder by gently tipping it back and forth 5-10 times until the powder is dissolved.

When you are mixing your Genotropin, **DO NOT SHAKE** the solution. Mix it gently. Shaking the solution could make your growth hormone foam and damage the active substance. Check the solution and do not inject if the solution is cloudy or has particles in it.

- **Injecting Genotropin:**

Remember to wash your hands and clean your skin first.

Inject your growth hormone at about the same time every day. Bedtime is a good time because it is easy to remember. It is also natural to have a higher level of growth hormone at night.

Most people do their injections into their thigh or their bottom. Do your injection in the place you have been shown by your doctor. Fatty tissue of the skin can shrink at the site of injection. To avoid this, use a slightly different place for your injection each time. This gives your skin and the area under your skin time to recover from one injection before it gets another one in the same place.

Remember to put your Genotropin back in the refrigerator straight after your injection.

If you use more Genotropin than you should

If you inject much more than you should, contact your doctor or pharmacist as soon as possible. Your blood sugar level could fall too low and later rise too high. You might feel shaky, sweaty, sleepy or “not yourself”, and you might faint.

If you forget to use Genotropin

Do not use a double dose to make up for a forgotten dose.

It is best to use your growth hormone regularly. If you forget to use a dose, have your next injection at the usual time the next day. Keep a note of any missed injections and tell your doctor at your next check-up.

If you stop using Genotropin

Ask for advice from your doctor before you stop using Genotropin.

If you have any further questions on the use of this product, ask your doctor or pharmacist.

4. Possible side effects

Like all medicines, Genotropin can cause side effects, although not everybody gets them.

The very common and common side effects in adults may start within the first months of treatment and may either stop spontaneously or if your dose is reduced.

Very common side effects (may affect more than 1 in 10 people) include:

In adults

- Joint pain.
- Water retention (which shows as puffy fingers or swollen ankles).

Common side effects (may affect up to 1 in 10 people) include:

In children:

- Temporary reddening, itchiness or pain at the injection site.
- Joint pain.
- Rash.
- Raised itchy bumps on the skin.

In adults:

- Numbness / tingling.
- Stiffness in the arms and legs, muscle pain.

- Pain or burning sensation in the hands or underarms (known as Carpal Tunnel Syndrome).

Uncommon side effects (may affect up to 1 in 100 people) include:

In children:

- Water retention (which shows as puffy fingers or swollen ankles, for a short time at the start of treatment).
- Itching.

Rare side effects (may affect up to 1 in 1,000 people) include:

In children:

- Numbness / tingling.
- Leukaemia (This has been reported in a small number of growth hormone deficiency patients, some of whom have been treated with somatotropin. However, there is no evidence that leukaemia incidence is increased in growth hormone recipients without predisposing factors).
- Increased intracranial pressure (which causes symptoms such as strong headache, visual disturbances or vomiting).
- Muscle pain.

Not known: frequency cannot be estimated from the available data

- Type 2 diabetes.
- A decrease in the levels of the hormone Cortisol in your blood.
- Facial swelling.

In children:

- Stiffness in the arms and legs.

In adults:

- Increased intracranial pressure (which causes symptoms such as strong headache, visual disturbances or vomiting).
- Reddening, itchiness or pain at the injection site.
- Rash.
- Itching.
- Raised itchy bumps on the skin.

Formation of antibodies to the injected growth hormone but these do not seem to stop the growth hormone from working.

The skin around the injection area can get uneven or lumpy, but this should not happen if you inject in a different place each time.

A very rare side effect that can occur because of the preservative metacresol is inflammation of the muscles near the injection site. If your doctor confirms that you have developed this, you should use a Genotropin product without metacresol.

There have been rare cases of sudden death in patients with Prader-Willi syndrome. However, no link has been made between these cases and treatment with Genotropin.

Slipped capital femoral epiphysis and Legg-Calve-Perthes disease may be considered by your doctor if discomfort or pain in the hip or knee is experienced whilst being treated with Genotropin.

Other possible side effects related to your treatment with growth hormone may include the following. You (or your child) may experience a high blood sugar or reduced levels of thyroid hormone. This can be tested by your doctor and if necessary your doctor will prescribe the adequate treatment. Rarely, an inflammation of the pancreas has been reported in patients treated with growth hormone.

If any of the side effects gets serious, or if you notice any side effects not listed in this leaflet, please tell your doctor or pharmacist.

Reporting of side effects

If you get any side effects, talk to your doctor, pharmacist or nurse. This includes any possible side effects not listed in this leaflet. You can also report side effects directly via the Yellow Card Scheme at: www.mhra.gov.uk/yellowcard or search for MHRA Yellow Card in the Google Play or Apple App Store. By reporting side effects you can help provide more information on the safety of this medicine.

5. How to store Genotropin

Keep out of the sight and reach of children.

Do not use this medicine after the expiry date which is stated on the carton as MM/YYYY. The expiry date refers to the last day of that month.

Before reconstitution:

Store in a refrigerator (2°C – 8°C). Keep the two-chamber cartridge in the outer carton in order to protect from light.

Before opening, the product may be taken out of the refrigerator, without being replaced, for a maximum period of 1 month at a temperature not above 25°C but after this it must be discarded.

After reconstitution:

Store in a refrigerator (2°C – 8°C) for up to 4 weeks. Do not freeze. Keep the GoQuick pre-filled pen in the GoQuick outer carton, or the two-chamber cartridge in the Pen box in order to protect from light.

Do not use this medicine if you notice particles or if the solution is not clear.

Do not freeze or expose Genotropin to frost. If it freezes, do not use it.

Never throw away needles or partly used or empty cartridges with your ordinary rubbish. When you have finished with a needle, you must discard it carefully so that no-one will be able to use it or prick themselves on it. You can get a special “sharps” bin from your hospital or growth clinic.

Do not throw away any medicines via wastewater or household waste. Ask your pharmacist how to throw away medicines you no longer use. These measures will help protect the environment.

6. Contents of the pack and other information

What Genotropin contains

- The active substance is somatropin*.
- One cartridge contains 5.3 mg or 12 mg of somatropin*.
- After reconstitution the concentration of somatropin* is 5.3 mg or 12 mg per ml.
- The other ingredients in the powder are: glycine (E640), mannitol (E421), sodium dihydrogen phosphate anhydrous (E339), and disodium phosphate anhydrous (E339) (see section 2 “Genotropin contains sodium”).
- The ingredients in the solvent are: water for injections, mannitol (E421) and metacresol.

* Produced in *Escherichia coli* cells by recombinant DNA technology

What Genotropin looks like and contents of the pack

Genotropin is a powder and solvent for solution for injection, in a two-chamber cartridge containing the powder in one section and the solvent in the other (5.3 mg/ml or 12 mg/ml). The cartridge may be contained in a pre-filled pen. Pack size of 1 or 5 pre-filled pen(s), or 1 or 5 or 20 cartridge(s).

Not all strengths and pack sizes may be marketed.

The powder is white and the solvent is clear.

You can use the cartridges in a specific pen injection device for Genotropin. Genotropin cartridges are colour coded and must be used with the matching colour coded Genotropin Pen to give the correct dose: The Genotropin 5.3 mg cartridge (blue) must be used with the Genotropin Pen 5.3 (blue). The Genotropin 12 mg cartridge (purple) must be used with the Genotropin Pen 12 (purple).

The instructions for use of the device are enclosed in the device package. You should ask your doctor for an injection or reconstitution device if you do not already have one.

Marketing Authorisation Holder

Pfizer Limited,
Ramsgate Road,
Sandwich,
Kent, CT13 9NJ,
United Kingdom

Manufacturer

Pfizer Manufacturing Belgium NV
Rijksweg 12
2870 Puurs
Belgium

This medicinal product is authorised in the Member States of the EEA under the following names:
Genotropin: Austria, Denmark, Finland, Germany, Greece, Ireland, Italy, Netherlands, Portugal, Sweden, United Kingdom
Genotonorm: Belgium, France, Luxembourg
Genotonorm Kabipen: Spain

This leaflet was last approved in: 10/2020

Ref: GN35_0

GENOTROPIN GOQUICK®

INSTRUCTIONS FOR USE

Important Information

Please read these instructions completely before using GoQuick.

If you have any questions about your dose or your treatment with Genotropin, call your doctor or nurse.

About GoQuick

GoQuick is a prefilled, multidose, disposable injection pen that holds 5.3 mg of somatotropin. The Genotropin in the pen is mixed only once, when you start a new pen. A single pen can be used up to 28 days after mixing. You never have to change cartridges. When the pen is empty, you just start a new pen.

The pen has dose memory. The dose is set once on a new pen. The pen then gives the same dose for each injection. You can use the pen with or without the optional needle guard.

Before You Use GoQuick

- Get training from your doctor or nurse.
- Know your dose. Know the pen parts.
- Make sure you have the pen with the blue injection button.
- Wash your hands.

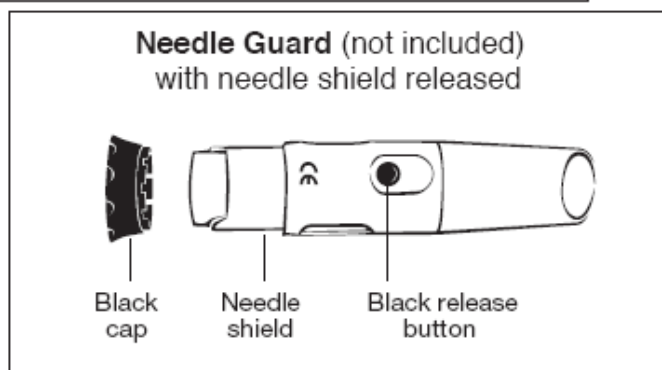
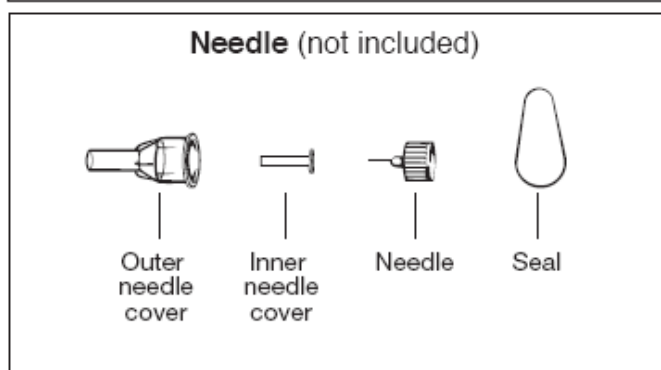
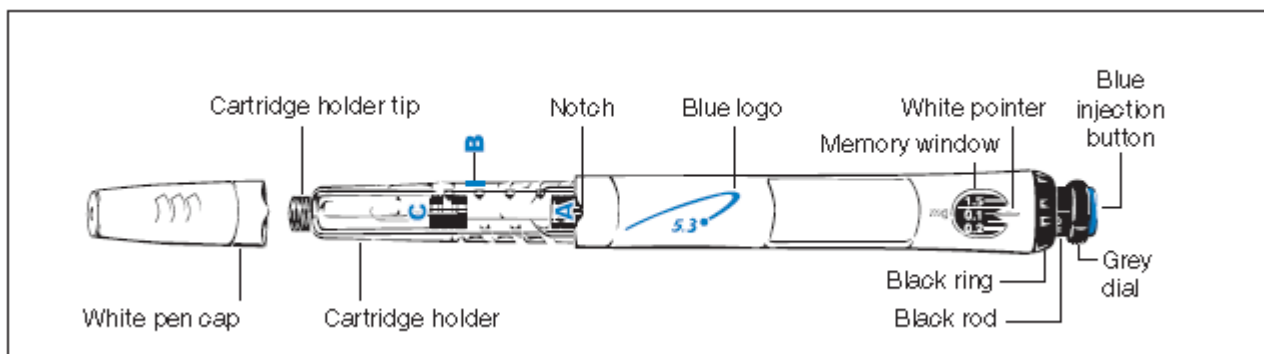

Setting Up and Using a New GoQuick

Step 1. Attach the Needle

- a. Pull the white pen cap straight off the pen.
- b. Peel the seal from a new needle.
- c. Firmly grasp the cartridge holder. (Figure 1)
- d. Push the needle onto the cartridge holder tip.
- e. Gently screw the needle onto the pen. Do not overtighten.
- f. Leave both needle covers on the needle.

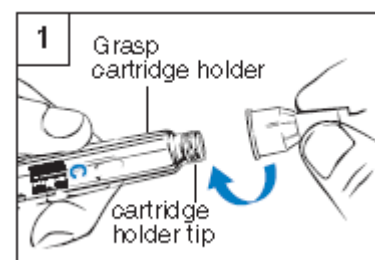

Step 2. Mix the Genotropin

- a. Hold the pen with the needle-end pointing up and the **A** facing you. (Figure 2)
- b. **Firmly** twist the cartridge holder into the pen until **B** clicks into the notch.
 - Gently tilt the pen from side to side. Do not shake the pen. Shaking may damage the growth hormone.
- c. Check that the liquid in the cartridge is clear. All the powder should be dissolved.
 - If not, gently tilt the pen from side to side a few more times.
- d. Check the liquid again. Make sure it is clear.
 - If the liquid is clear, go to Step 3.
 - If the liquid is still cloudy or you see any powder, use a new pen.

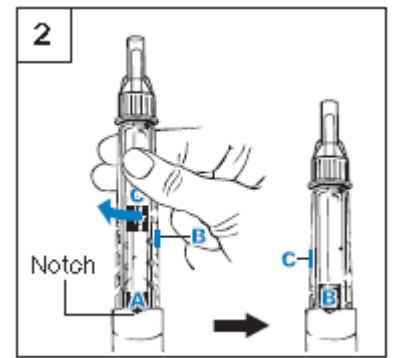

Step 3. Remove the Air

- a. Pull the outer needle cover off. Save it to remove the needle. (Figure 3a)
- b. Leave the inner needle cover on.
- c. Hold the pen with the needle-end pointing up. (Figure 3b)
- d. Tap the cartridge holder gently to help any trapped air move to the top.
- e. **Firmly**, twist the cartridge holder into the pen until **C** clicks into the notch.
 - Some liquid may appear around the inner needle cover.

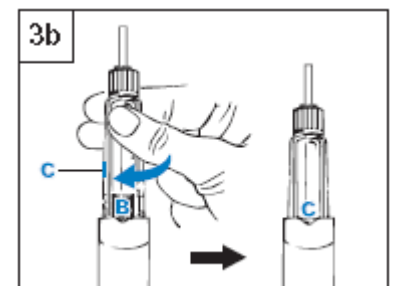
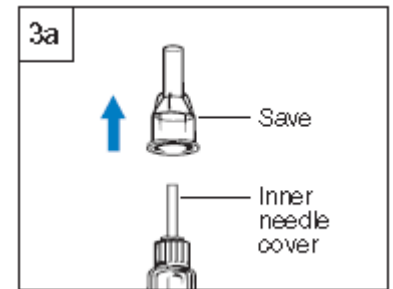

Step 4. Attach the Needle Guard (Optional)

- a. Pull the black cap off the needle guard. (Figure 4a)
 - If the needle shield slides out, push it back into the needle guard until it clicks into place.
- b. Hold the pen in one hand below the blue logo. With the other hand, hold the needle guard below the needle shield. (Figure 4b)
- c. Line up the black logo on the needle guard with the blue logo on the pen. Carefully push the needle guard onto the pen until it snaps into place.

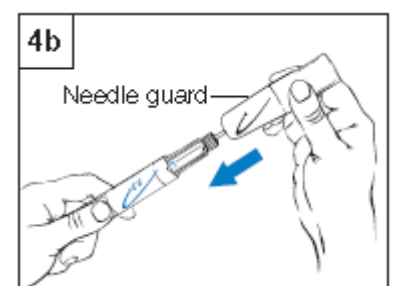
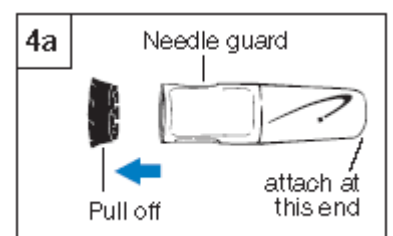

Step 5. Prime the Pen

- a. Pull the inner needle cover off. Throw it away. (Figure 5a)

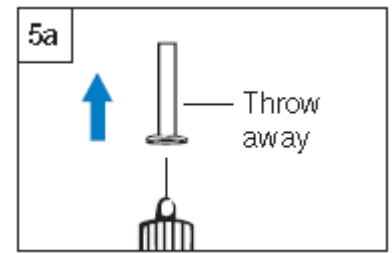

- b. Check that 0.1 mg is set in the memory window.
c. Turn the grey dial in the direction of the arrows until it stops clicking. (Figure 5b)

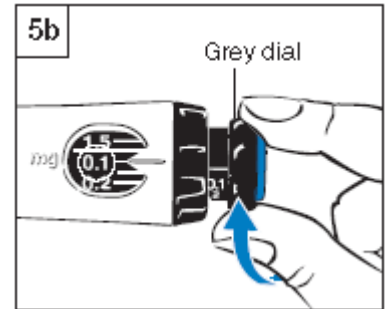

- d. Hold the pen with the needle pointing up. (Figure 5c with and without needle guard)
e. Push the blue injection button until liquid appears.
f. If liquid does not appear at Step “e”, repeat Steps b-e in this section up to two more times.
g. If liquid still does not appear, do not use the pen.
 - See the Questions and Answers section below for more information.

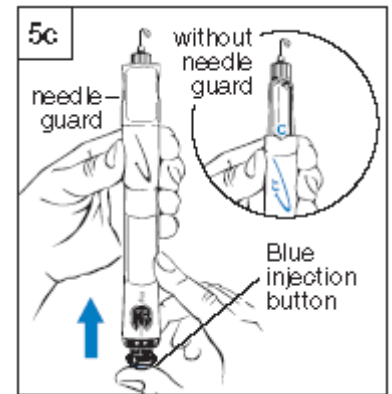

- h. If you use the needle guard, press the black button to release the needle shield. (Figure 5d)

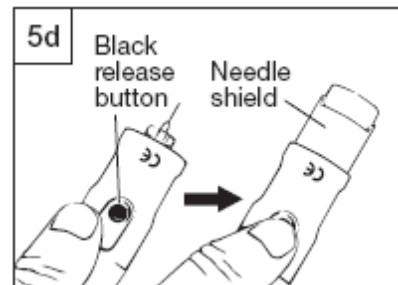

Step 6. Set the Dose

- Use the black ring to set the dose. Be careful not to turn the grey dial while setting the dose.
- a. Hold the black ring as shown in Figure 6.
b. Turn the black ring until your dose lines up with the white pointer. Your doctor or nurse has told you your dose.
c. If you turn your dose past the white pointer, just turn the black ring back to set the correct dose.
d. Once you have set your dose, do not change it unless your doctor or nurse tells you.

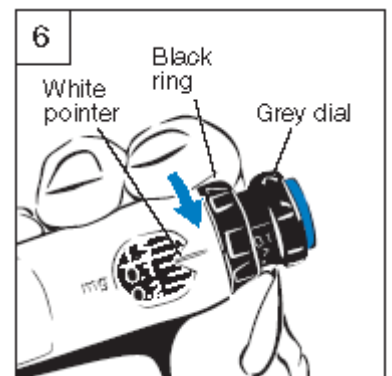

Note: If you cannot turn the black ring, press in the blue injection button until it stops clicking. Then continue to set your dose using the black ring (for more information, see also the Questions and Answers section below).

Step 7. Draw Up a Dose

- Turn the grey dial in the direction of the arrow until the clicking stops. (Figure 7a)
- Your dose on the black rod should line up with the white pointer.

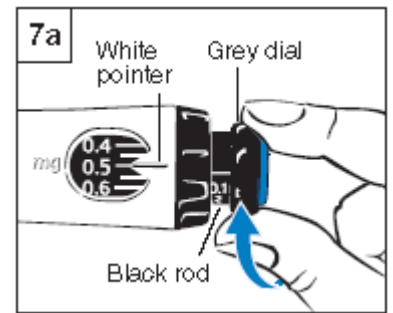

- Check that the dose you drew up on the black rod is the same as the dose you set in the memory window. Figure 7b shows an example.
- If the doses do not match, make sure you have turned the grey dial in the direction of the arrow until it does not click anymore.

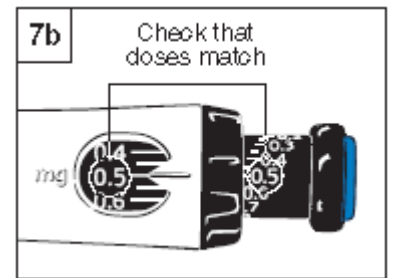

Step 8. Give the Injection

- Prepare an injection site as your doctor or nurse has told you.
- Hold the pen over the injection site.
- Push the pen down to insert the needle into the skin.
- Using your thumb, push the blue injection button down until it stops clicking. (Figure 8)
 - Count for 5 seconds before you pull the needle out of the skin. Keep light pressure on the button with your thumb while you count.
- Pull the pen straight out from the skin.

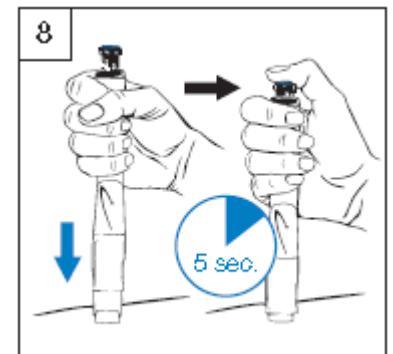

Step 9. Remove the Needle; Cap and Store Your Pen

Step 9a: With needle guard

- Place the outer needle cover into the end of the needle shield. (Figure 9a)
- Use the needle cover to push in the needle shield until it locks into place.
- Use the needle cover to unscrew the needle and put it in a proper container for used needles.
- Leave the needle guard on the pen.
- Place the black cap on the needle guard. Store your pen in the refrigerator.

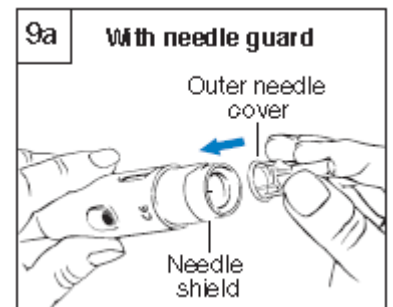

Step 9b: Without needle guard

- Do not touch the needle.
- Carefully cover the needle with the outer needle cover. (Figure 9b)
- Use the needle cover to unscrew the needle and put it in a proper container for used needles.
- Place the white cap on the pen. Store your pen in the refrigerator.

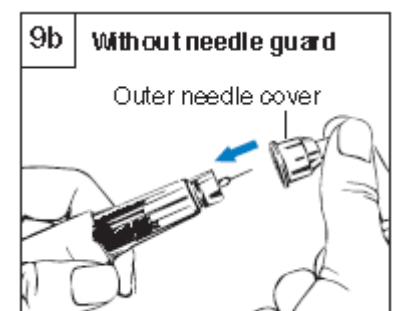

Routine Use of GoQuick

1. Pull the black cap from the needle guard or the white cap from the pen.

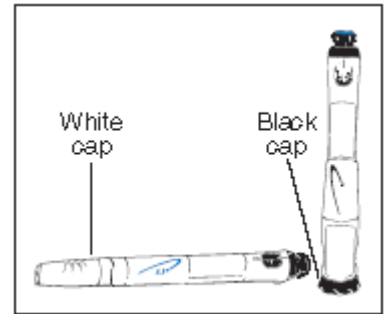

2. Attach a new needle.
 - With the needle guard:
 - If the needle shield releases, push it back into place.
 - Attach a new needle to the cartridge holder tip.

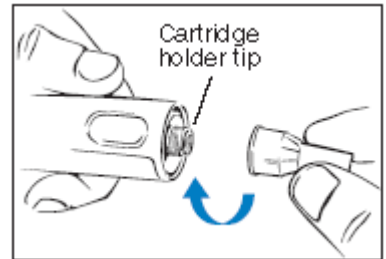

- Without the needle guard:
 - Attach a new needle to the cartridge holder tip.

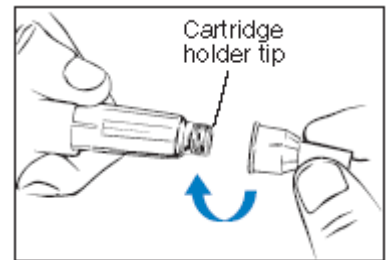

3. Remove both needle covers. Save the outer needle cover to remove the needle.

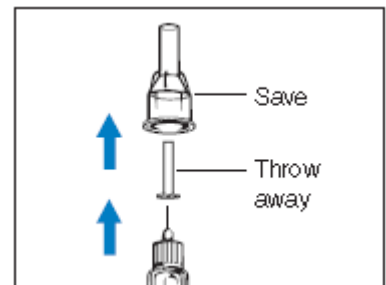

4. If you use the needle guard, press the black release button to extend the needle shield.

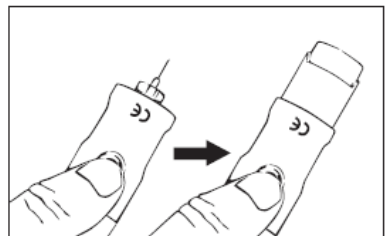

- To draw up the dose, turn the grey dial until it stops clicking.

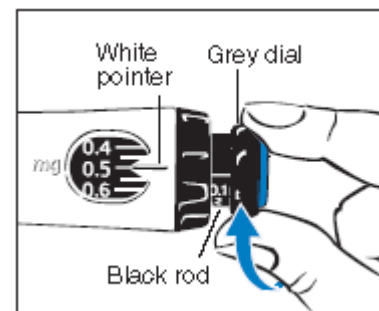

- Check that the dose you drew up is the same as the dose you set in the memory window.
 - If the dose you drew up is smaller, the pen does not have a full dose of Genotropin.
 - Follow what your doctor or nurse told you to do when the pen does not have a full dose left.

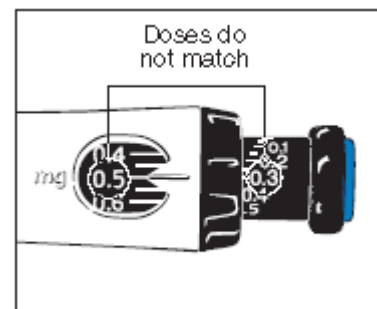

- Prepare an injection site as your doctor or nurse has told you.

- Give the injection.
 - Push the pen down to insert the needle into the skin.
 - Push the blue injection button down until it stops clicking.
 - Count for 5 seconds before you pull the needle out of the skin. Keep light pressure on the button with your thumb while you count.
 - Pull the pen straight out from the skin.

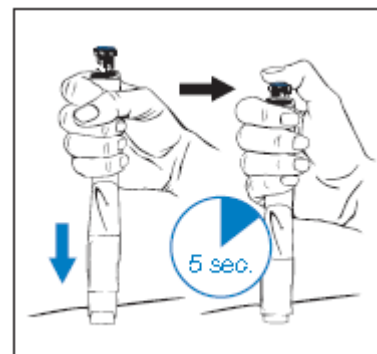

- Remove the needle.
 - With the needle guard:
 - Use the outer needle cover to push in the needle shield until it locks into place.
 - Without the needle guard:
 - Carefully cover the needle with the outer needle cover.
 - Use the outer needle cover to unscrew the needle. Throw the needle away in a proper container for used needles.

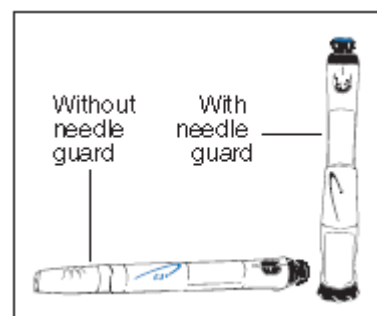

- Cap your needle guard or pen and store it in the refrigerator.

ADDITIONAL INFORMATION

Storage

- See the **other side of this** leaflet for how to store your GoQuick.
- After 4 weeks, dispose of the pen (or discard) even if there is some medicine left.
- Do not freeze or expose GoQuick to frost.
- Do not use your GoQuick after its expiry date.
- Follow your local health and safety laws to dispose of (or discard) your pen. Ask your doctor or nurse, if you are not sure what to do.

Handling

- Do not mix the powder and liquid of GoQuick unless a needle is on the pen.
- Do not store your GoQuick with the needle attached. The Genotropin may leak from the pen and air bubbles may form in the cartridge. Always remove the needle and attach the pen cap or needle guard cap before storing.
- Take care not to drop your GoQuick.
- If you do drop the pen you must perform another prime as described in Step 5 (Setting Up and Using a New GoQuick). But if any part of your GoQuick appears broken or damaged, do not use the pen. Contact your doctor or nurse for another pen.
- Clean the pen and needle guard with a damp cloth. Do not put the pen in water.

Needles

- Always use a new needle for each injection.
- Put all used needles in an appropriate “sharps” container. Follow your local health and safety laws to dispose of your needles. Ask your doctor or nurse, if you are not sure what to do.
- Do not share your pen or needles.

General

- The numbers and lines on the cartridge holder can help you estimate how much Genotropin is left in the pen.
- If in routine use Step 6 the pen does not have a full dose of Genotropin, the scale on the black rod indicates the amount of drug remaining in the pen.
- Patients who are blind or who do not see well should only use GoQuick with the help of someone trained to use the pen.
- Follow your doctor or nurse’s instructions for cleaning your hands and skin when you prepare and give the injection.
- Do not discard your needle guard, to remove it from the pen just twist it off. Save it to use with each new pen.
- If you have questions about how to use GoQuick, ask your doctor or nurse.

QUESTIONS AND ANSWERS

Question

What should I do if I see more than a small drop of liquid on the needle after giving my injection?

Answer

For your next injection wait the full time of 5 seconds before taking the needle from the skin. If you still see some liquid after you take out the needle, hold in for a little longer next time.

Is it a problem if I see air bubbles in the cartridge?

No, small amounts of air may be present in the cartridge during normal use.

What should I do if I see Genotropin leaking from the pen?

Make sure that the needle has been attached correctly.

What should I do if the pen that I am using was not put in the refrigerator overnight?

Discard the pen and use a new GoQuick.

What should I do if I can’t turn the black ring?

You have probably accidentally turned the grey dial. If you have turned the grey dial the pen will prevent you from turning the black ring so that your dose does not change during your injection.

To release the black ring, press in the blue injection button until it stops. Note that liquid will come out of the needle. Then continue to set

What if my doctor changes my dose when I've already started a pen?	your dose using the black ring. Set the new dose by turning the black ring.
What if I inject the wrong dose?	Call your doctor or nurse immediately and follow his/her instructions.
What if my pen will not prime (i.e. if liquid did not appear in step 5g)?	Call your doctor or nurse and follow his/her instructions.
What doses can my pen deliver?	The pen can deliver doses from 0.10mg to 1.5mg of Genotropin. Each click of the black ring changes the dose by 0.05mg.

GOQUICK®

INSTRUCTIONS FOR USE

Important Information

Please read these instructions completely before using GoQuick.

If you have any questions about your dose or your treatment with Genotropin, call your doctor or nurse.

About GoQuick

GoQuick is a prefilled, multidose, disposable injection pen that holds 12 mg of somatotropin. The Genotropin in the pen is mixed only once, when you start a new pen. A single pen can be used up to 28 days after mixing. You never have to change cartridges. When the pen is empty, you just start a new pen.

The pen has dose memory. The dose is set once on a new pen. The pen then gives the same dose for each injection. You can use the pen with or without the optional needle guard.

Before You Use GoQuick

- Get training from your doctor or nurse.
- Know your dose. Know the pen parts.
- Make sure you have the pen with the purple injection button.
- Wash your hands.

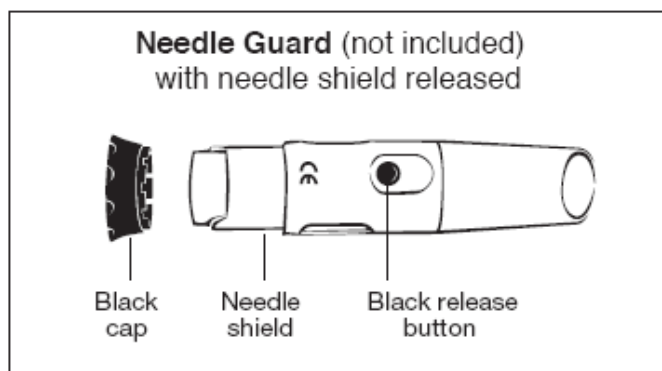
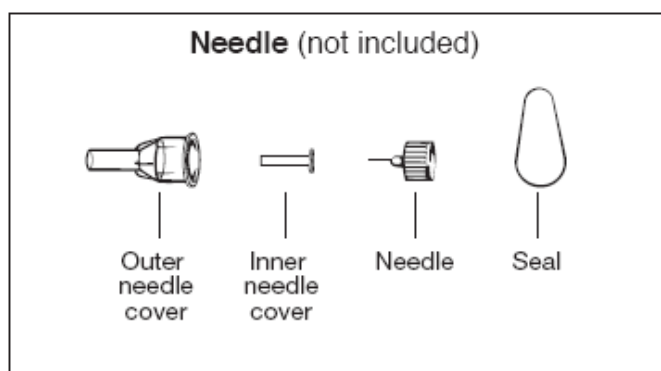
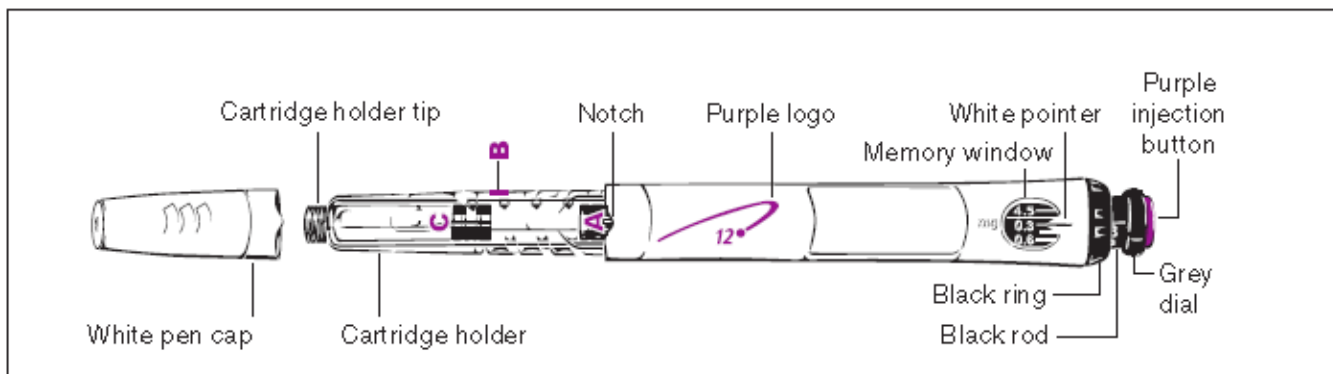

Setting Up and Using a New GoQuick

Step 1. Attach the Needle

- a. Pull the white pen cap straight off the pen.
- b. Peel the seal from a new needle.
- c. Firmly grasp the cartridge holder. (Figure 1)
- d. Push the needle onto the cartridge holder tip.
- e. Gently screw the needle onto the pen. Do not overtighten.
- f. Leave both needle covers on the needle.

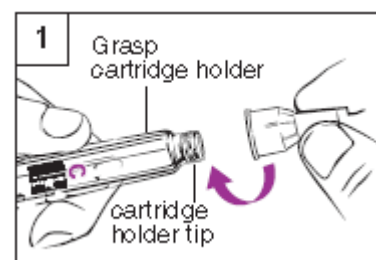

Step 2. Mix the Genotropin

- a. Hold the pen with the needle-end pointing up and the **A** facing you. (Figure 2)
- b. **Firmly** twist the cartridge holder into the pen until **B** clicks into the notch.
 - Gently tilt the pen from side to side. Do not shake the pen. Shaking may damage the growth hormone.
- c. Check that the liquid in the cartridge is clear. All the powder should be dissolved.
 - If not, gently tilt the pen from side to side a few more times.
- d. Check the liquid again. Make sure it is clear.
 - If the liquid is clear, go to Step 3.
 - If the liquid is still cloudy or you see any powder, use a new pen.

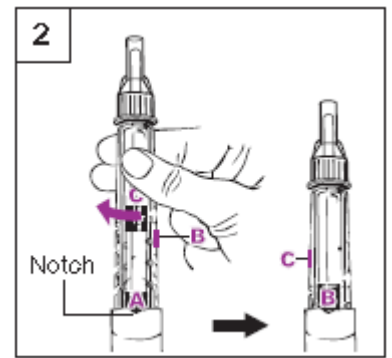

Step 3. Remove the Air

- a. Pull the outer needle cover off. Save it to remove the needle. (Figure 3a)
- b. Leave the inner needle cover on.

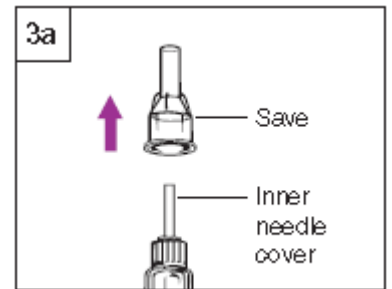

- c. Hold the pen with the needle-end pointing up. (Figure 3b)
- d. Tap the cartridge holder gently to help any trapped air move to the top.
- e. **Firmly**, twist the cartridge holder into the pen until **C** clicks into the notch.
 - Some liquid may appear around the inner needle cover.

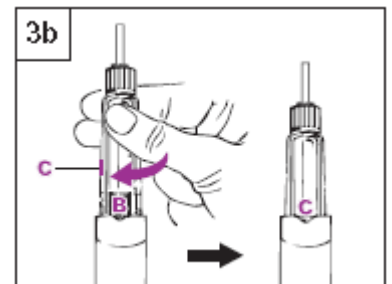

Step 4. Attach the Needle Guard (Optional)

- a. Pull the black cap off the needle guard. (Figure 4a)
 - If the needle shield slides out, push it back into the needle guard until it clicks into place.

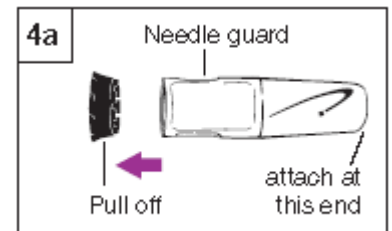

- b. Hold the pen in one hand below the purple logo. With the other hand, hold the needle guard below the needle shield. (Figure 4b)
- c. Line up the black logo on the needle guard with the purple logo on the pen. Carefully push the needle guard onto the pen until it snaps into place.

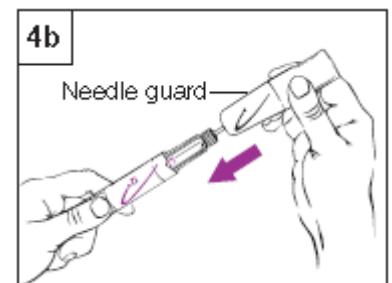

Step 5. Prime the Pen

- a. Pull the inner needle cover off. Throw it away. (Figure 5a)

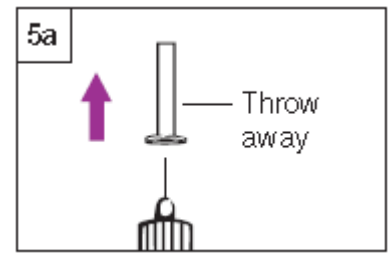

- b. Check that 0.3 mg is set in the memory window.
c. Turn the grey dial in the direction of the arrows until it stops clicking. (Figure 5b)

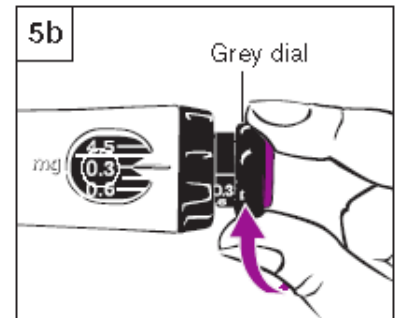

- d. Hold the pen with the needle pointing up. (Figure 5c with and without needle guard)
e. Push the purple injection button until liquid appears.
f. If liquid does not appear at Step "e", repeat Steps b-e in this section up to two more times.
g. If liquid still does not appear, do not use the pen.
 - See the Questions and Answers section below for more information.

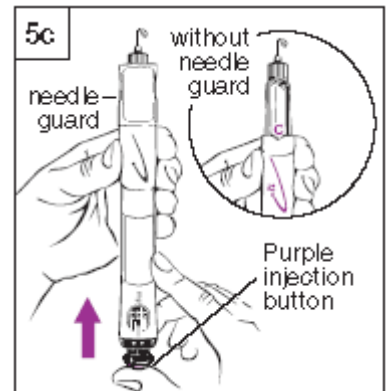

- h. If you use the needle guard, press the black button to release the needle shield. (Figure 5d)

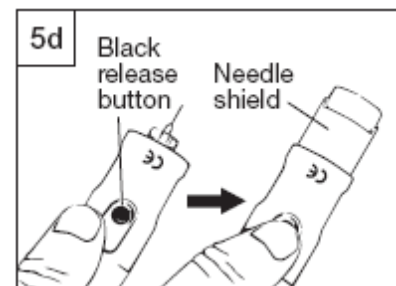

Step 6. Set the Dose

- Use the black ring to set the dose. Be careful not to turn the grey dial while setting the dose.
- a. Hold the black ring as shown in Figure 6.
b. Turn the black ring until your dose lines up with the white pointer. Your doctor or nurse has told you your dose.
c. If you turn your dose past the white pointer, just turn the black ring back to set the correct dose.
d. Once you have set your dose, do not change it unless your doctor or nurse tells you.

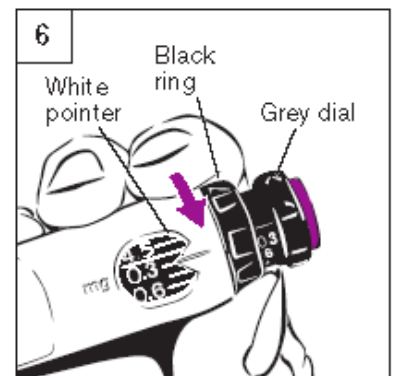

Note: If you cannot turn the black ring, press in the purple injection button until it stops clicking. Then continue to set your dose using the black ring (for more information, see also the Questions and Answers section below).

Step 7. Draw Up a Dose

- Turn the grey dial in the direction of the arrow until the clicking stops. (Figure 7a)
- Your dose on the black rod should line up with the white pointer.

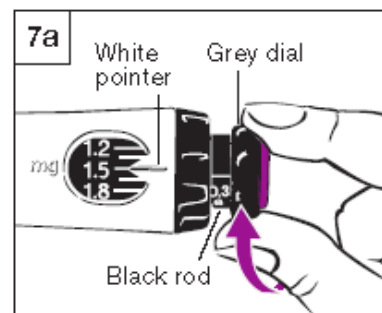

- Check that the dose you drew up on the black rod is the same as the dose you set in the memory window. Figure 7b shows an example.
- If the doses do not match, make sure you have turned the grey dial in the direction of the arrow until it does not click anymore.

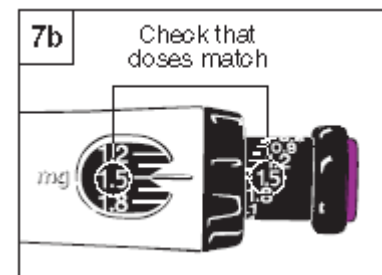

Step 8. Give the Injection

- Prepare an injection site as your doctor or nurse has told you.
- Hold the pen over the injection site.
- Push the pen down to insert the needle into the skin.
- Using your thumb, push the purple injection button down until it stops clicking. (Figure 8)
 - Count for 5 seconds before you pull the needle out of the skin. Keep light pressure on the button with your thumb while you count.
- Pull the pen straight out from the skin.

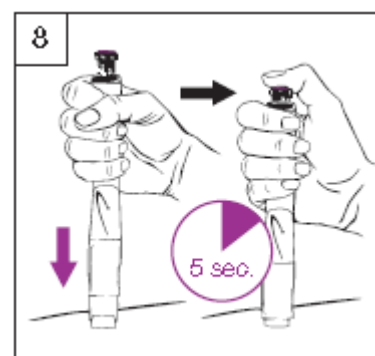

Step 9. Remove the Needle; Cap and Store Your Pen

Step 9a: With needle guard

- Place the outer needle cover into the end of the needle shield. (Figure 9a)
- Use the needle cover to push in the needle shield until it locks into place.
- Use the needle cover to unscrew the needle and put it in a proper container for used needles.
- Leave the needle guard on the pen.
- Place the black cap on the needle guard. Store your pen in the refrigerator.

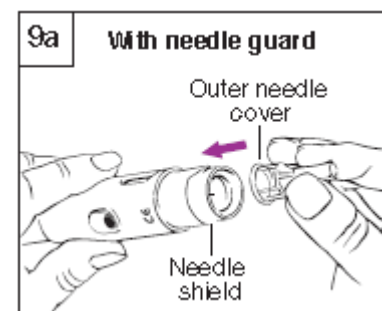

Step 9b: Without needle guard

- Do not touch the needle.
- Carefully cover the needle with the outer needle cover. (Figure 9b)
- Use the needle cover to unscrew the needle and put it in a proper container for used needles.
- Place the white cap on the pen. Store your pen in the refrigerator.

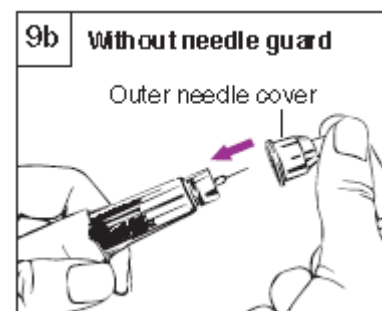

Routine Use of GoQuick

1. Pull the black cap from the needle guard or the white cap from the pen.

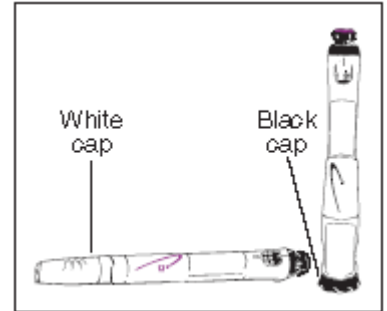

2. Attach a new needle.
 - With the needle guard:
 - If the needle shield releases, push it back into place.
 - Attach a new needle to the cartridge holder tip.

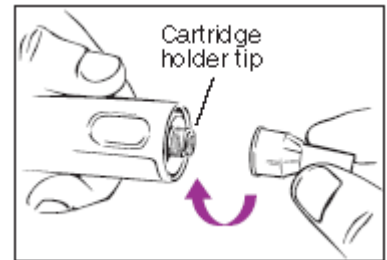

- Without the needle guard:
 - Attach a new needle to the cartridge holder tip.

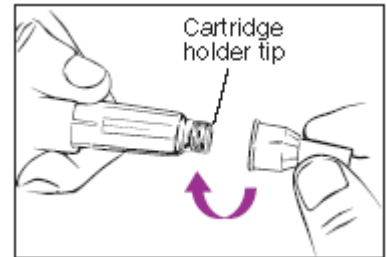

3. Remove both needle covers. Save the outer needle cover to remove the needle.

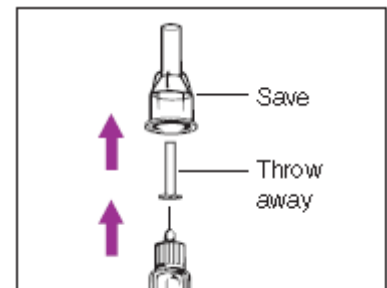

4. If you use the needle guard, press the black release button to extend the needle shield.

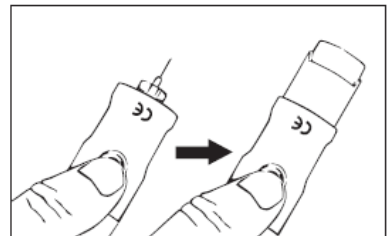

5. To draw up the dose, turn the grey dial until it stops clicking.

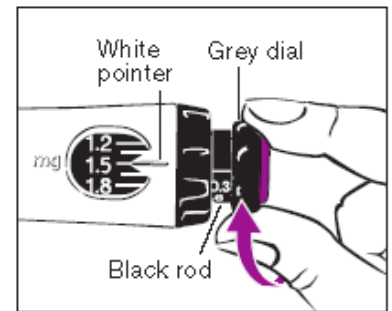

6. Check that the dose you drew up is the same as the dose you set in the memory window.
- If the dose you drew up is smaller, the pen does not have a full dose of Genotropin.
 - Follow what your doctor or nurse told you to do when the pen does not have a full dose left.

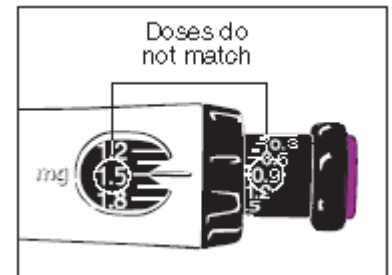

7. Prepare an injection site as your doctor or nurse has told you.

8. Give the injection.
- Push the pen down to insert the needle into the skin.
 - Push the purple injection button down until it stops clicking.
 - Count for 5 seconds before you pull the needle out of the skin. Keep light pressure on the button with your thumb while you count.
 - Pull the pen straight out from the skin.

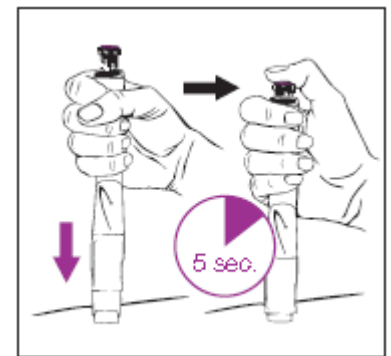

9. Remove the needle.
- With the needle guard:
 - Use the outer needle cover to push in the needle shield until it locks into place.
 - Without the needle guard:
 - Carefully cover the needle with the outer needle cover.
 - Use the outer needle cover to unscrew the needle. Throw the needle away in a proper container for used needles.

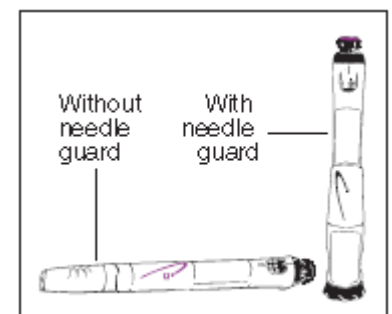

10. Cap your needle guard or pen and store it in the refrigerator.

ADDITIONAL INFORMATION

Storage

- See the **other side of this** leaflet for how to store your GoQuick.
- After 4 weeks, dispose of the pen (or discard) even if there is some medicine left.
- Do not freeze or expose GoQuick to frost.
- Do not use your GoQuick after its expiry date.
- Follow your local health and safety laws to dispose of (or discard) your pen. Ask your doctor or nurse, if you are not sure what to do.

Handling

- Do not mix the powder and liquid of GoQuick unless a needle is on the pen.
- Do not store your GoQuick with the needle attached. The Genotropin may leak from the pen and air bubbles may form in the cartridge. Always remove the needle and attach the pen cap or needle guard cap before storing.
- Take care not to drop your GoQuick.
- If you do drop the pen you must perform another prime as described in Step 5 (Setting Up and Using a New GoQuick). But if any part of your GoQuick appears broken or damaged, do not use the pen. Contact your doctor or nurse for another pen.
- Clean the pen and needle guard with a damp cloth. Do not put the pen in water.

Needles

- Always use a new needle for each injection.
- Put all used needles in an appropriate “sharps” container. Follow your local health and safety laws to dispose of your needles. Ask your doctor or nurse, if you are not sure what to do.
- Do not share your pen or needles.

General

- The numbers and lines on the cartridge holder can help you estimate how much Genotropin is left in the pen.
- If in routine use Step 6 the pen does not have a full dose of Genotropin, the scale on the black rod indicates the amount of drug remaining in the pen.
- Patients who are blind or who do not see well should only use GoQuick with the help of someone trained to use the pen.
- Follow your doctor or nurse’s instructions for cleaning your hands and skin when you prepare and give the injection.
- Do not discard your needle guard, to remove it from the pen just twist it off. Save it to use with each new pen.
- If you have questions about how to use GoQuick, ask your doctor or nurse.

QUESTIONS AND ANSWERS

Question

What should I do if I see more than a small drop of liquid on the needle after giving my injection?

Answer

For your next injection wait the full time of 5 seconds before taking the needle from the skin. If you still see some liquid after you take out the needle, hold in for a little longer next time.

Is it a problem if I see air bubbles in the cartridge?

No, small amounts of air may be present in the cartridge during normal use.

What should I do if I see Genotropin leaking from the pen?

Make sure that the needle has been attached correctly.

What should I do if the pen that I am using was not put in the refrigerator overnight?

Discard the pen and use a new GoQuick.

What should I do if I can’t turn the black ring?

You have probably accidentally turned the grey dial. If you have turned the grey dial the pen will prevent you from turning the black ring so that your dose does not change during your injection.

To release the black ring, press in the purple injection button until it stops. Note that liquid will come out of the needle. Then continue to set your dose using the black ring.

What if my doctor changes my dose when I've already started a pen?

Set the new dose by turning the black ring.

What if I inject the wrong dose?

Call your doctor or nurse immediately and follow his/her instructions.

What if my pen will not prime (i.e. if liquid did not appear in step 5g)?

Call your doctor or nurse and follow his/her instructions.

What doses can my pen deliver?

The pen can deliver doses from 0.30 mg to 4.5 mg of Genotropin. Each click of the black ring changes the dose by 0.15 mg.