

**Package leaflet: Information for the patient**  
**ORENCIA 50 mg solution for injection in pre-filled syringe**  
**ORENCIA 87.5 mg solution for injection in pre-filled syringe**  
**ORENCIA 125 mg solution for injection in pre-filled syringe**  
abatacept

**Read all of this leaflet carefully before you start using this medicine because it contains important information for you.**

- Keep this leaflet. You may need to read it again.
- If you have any further questions, ask your doctor, pharmacist or nurse.
- This medicine has been prescribed for you only. Do not pass it on to others. It may harm them, even if their signs of illness are the same as yours.
- If you get any side effects, talk to your doctor, pharmacist or nurse. This includes any possible side effects not listed in this leaflet. See section 4.

**What is in this leaflet**

1. What ORENCIA is and what it is used for
2. What you need to know before you use ORENCIA
3. How to use ORENCIA
4. Possible side effects
5. How to store ORENCIA
6. Contents of the pack and other information

**1. What ORENCIA is and what it is used for**

ORENCIA contains the active substance abatacept, a protein produced in cell cultures. ORENCIA lessens the immune system's attack on normal tissues by interfering with the immune cells (called T lymphocytes) that contribute to the development of rheumatoid arthritis. ORENCIA selectively modulates the activation of T cells involved in the immune system's inflammatory response.

ORENCIA is used to treat rheumatoid arthritis and psoriatic arthritis in adults and also polyarticular juvenile idiopathic arthritis in children 2 years of age and older.

Rheumatoid Arthritis

Rheumatoid arthritis is a long-term progressive systemic disease that, if untreated, can lead to serious consequences, such as joint destruction, increased disability and impairment of daily activities. In people with rheumatoid arthritis the body's own immune system attacks normal body tissues, leading to pain and swelling of the joints. This can cause joint damage. Rheumatoid arthritis (RA) affects everyone differently. In most people, joint symptoms develop gradually over several years. However, in some, RA may progress rapidly and yet other people may have RA for a limited period of time and then enter a period of remission. RA is usually a chronic (long-term), progressive disease. This means, even if you're on treatment, whether or not you're still having symptoms, RA could be continuing to damage your joints. By finding the right treatment plan for you, you may be able to slow down this disease process, which may help reduce long-term joint damage, as well as pain and fatigue and improve your overall quality of life.

ORENCIA is used to treat moderate to severe active rheumatoid arthritis when you do not respond well enough to treatment with other disease-modifying medicines or with another group of medicines called 'tumour necrosis factor (TNF) blockers'. It is used in combination with a medicine called methotrexate.

ORENCIA can also be used with methotrexate to treat highly active and progressive rheumatoid arthritis without previous methotrexate treatment.

ORENCIA is used to:

- slow down the damage to your joints
- improve your physical function

#### Psoriatic Arthritis

Psoriatic arthritis is an inflammatory disease of the joints, usually accompanied by psoriasis, an inflammatory disease of the skin. If you have active psoriatic arthritis you will first be given other medicines. If you do not respond well enough to these medicines, you may be given ORENCIA to:

- Reduce the signs and symptoms of your disease.
- Slow down the damage to your bones and joints.
- Improve your physical function and your ability to do normal daily activities.

ORENCIA is used to treat psoriatic arthritis alone or in combination with methotrexate.

#### Polyarticular Juvenile Idiopathic Arthritis

Polyarticular juvenile idiopathic arthritis is a long-term inflammatory disease affecting one or more joints in children and adolescents.

ORENCIA solution for injection in pre-filled syringe is used in children and adolescents aged 2 to 17 years when a previous disease-modifying medicine has not worked well or is not suitable for them. ORENCIA is usually used in combination with methotrexate, although ORENCIA may also be used alone if treatment with methotrexate is inappropriate.

ORENCIA is used to:

- slow down the damage to joints
- improve physical function
- improve other signs and symptoms of polyarticular juvenile idiopathic arthritis

## **2. What you need to know before you use ORENCIA**

### **Do not use ORENCIA**

- **if you are allergic** to abatacept or any of the other ingredients of this medicine (listed in section 6).
- **if you have a severe or uncontrolled infection**, do not start treatment with ORENCIA. Having an infection could put you at risk of serious side effects from ORENCIA.

### **Warnings and precautions**

Talk to your doctor, pharmacist or nurse:

- **if you experience allergic reactions** such as chest tightness, wheezing, severe dizziness or lightheadedness, swelling or skin rash **tell your doctor immediately**.
- **if you have any kind of infection**, including long-term or localised infection, if you often get infections or **if you have symptoms of infection (e.g. fever, malaise, dental problems)**, **it is important to tell your doctor**. ORENCIA can lower your body's ability to fight infection and the treatment can make you more likely to get infections or make any infection you have worse.
- **if you have had tuberculosis (TB)** or have symptoms of tuberculosis (persistent cough, weight loss, listlessness, mild fever) **tell your doctor**. Before you use ORENCIA, your doctor will examine you for tuberculosis or do a skin test.
- **if you have viral hepatitis** tell your doctor. Before you use ORENCIA, your doctor may examine you for hepatitis.
- **if you have cancer**, your doctor will decide if you can still be given ORENCIA.
- **if you recently had a vaccination** or are planning to have one, **tell your doctor**. Some vaccines should not be given while you are receiving ORENCIA. **Check with your doctor before you are given any vaccines**. Certain vaccinations may cause infections from the vaccine. If you received ORENCIA while you were pregnant, your baby may be at a higher risk for getting such an infection for up to approximately 14 weeks after the last dose you received during pregnancy. It is important that you tell your baby's doctors and other health care professionals about your ORENCIA use during your pregnancy so they can decide when your baby should receive any vaccine.

Your doctor may also do tests to examine your blood values.

### **Children and adolescents**

ORENCIA solution for injection in pre-filled syringe has not been studied in children and adolescents under 2 years of age. Therefore, ORENCIA solution for injection in pre-filled syringe is not recommended for use in this patient population.

### **Other medicines and ORENCIA**

Tell your doctor if you are taking, have recently taken or might take any other medicines.

**ORENCIA should not be used** with biological medicines for rheumatoid arthritis, including TNF-blockers like adalimumab, etanercept, and infliximab; there is not enough evidence to recommend its being given with anakinra and rituximab.

**ORENCIA can be used** with other medicines commonly used to treat rheumatoid arthritis, such as steroids or painkillers, including non-steroidal anti-inflammatories such as ibuprofen or diclofenac. Ask your doctor or pharmacist for advice before taking any other medicine while using ORENCIA.

### **Pregnancy and breast-feeding**

The effects of ORENCIA in pregnancy are not known, so do not use ORENCIA if you are pregnant unless your doctor specifically recommends it.

- if you are a woman who could become pregnant, you must use reliable contraception (birth control) while using ORENCIA and up to 14 weeks after the last dose. Your doctor will advise you on suitable methods.
- if you become pregnant while using ORENCIA, tell your doctor.

If you received ORENCIA during your pregnancy, your baby may have a higher risk for getting an infection. It is important that you tell your baby's doctors and other health care professionals about your ORENCIA use during your pregnancy before the baby receives any vaccine (for more information see section on vaccination).

It is not known whether ORENCIA passes into human milk. **You must stop breast-feeding** if you are being treated with ORENCIA and for up to 14 weeks after the last dose.

### **Driving and using machines**

The use of ORENCIA is not expected to affect the ability to drive, cycle or use machines. However, if you are feeling tired or unwell after receiving ORENCIA, you should not drive, cycle or operate any machinery.

### **ORENCIA contains sodium**

This medicine contains less than 1 mmol sodium (23 mg) per dose, that is to say essentially 'sodium-free'.

## **3. How to use ORENCIA**

Always use this medicine exactly as your doctor or pharmacist has told you. Check with your doctor or pharmacist if you are not sure.

ORENCIA solution for injection is injected under the skin (subcutaneous use).

### **Recommended dose in adults**

The recommended dose of ORENCIA for adults with rheumatoid arthritis or psoriatic arthritis is 125 mg given every week regardless of weight.

Your doctor may start your ORENCIA treatment with or without a one-time dose of powder for concentrate for solution for infusion (given to you into a vein, usually in your arm, over a period of

30 minutes). If a single intravenous dose is given to start the treatment, the first subcutaneous injection of ORENCIA should be given within a day of the intravenous infusion, followed by the weekly 125 mg subcutaneous injections.

ORENCIA can be used by adults over 65 with no change in dose.

### **Use in children and adolescents**

For patients 2 to 17 years of age with polyarticular juvenile idiopathic arthritis, the recommended weekly dose of ORENCIA solution for injection in pre-filled syringe is based on body weight:

<b>Weekly Dose of ORENCIA</b>	
<b>Body Weight of Patient</b>	<b>Dose</b>
10 kg to less than 25 kg	50 mg
25 kg to less than 50 kg	87.5 mg
50 kg or more	125 mg

If you are already on intravenous ORENCIA treatment and wish to transition to ORENCIA subcutaneous, you should receive a subcutaneous injection instead of your next intravenous infusion, followed by weekly subcutaneous injections of ORENCIA.

Your doctor will advise you on the duration of treatment and what other medicines, including other disease-modifying medicines, if any, you may continue to take while on ORENCIA.

At the start, your doctor or nurse may inject ORENCIA. However, you and your doctor may decide that you can inject ORENCIA yourself. In this case, you will get training on how to inject ORENCIA yourself.

Talk to your doctor if you have any questions about giving yourself an injection. You will find detailed instructions for the preparation and administration of ORENCIA at the end of this leaflet (see "**Important instructions for use**").

### **If you use more ORENCIA than you should**

If this happens, contact immediately your doctor who will monitor you for any signs or symptoms of side effects, and treat these symptoms if necessary.

### **If you forget to use ORENCIA**

Keep track of your next dose. It is very important to use ORENCIA exactly as prescribed by your doctor. If you miss your dose within three days of when you are supposed to take it, take your dose as soon as you remember and then follow your original dosing schedule on your chosen day. If you miss your dose by more than three days, ask your doctor when to take your next dose.

### **If you stop using ORENCIA**

The decision to stop using ORENCIA should be discussed with your doctor.

If you have any further questions on the use of this medicine, **ask your doctor, pharmacist or nurse.**

## **4. Possible side effects**

Like all medicines, this medicine can cause side effects, although not everybody gets them. The most common side effects with ORENCIA are infections of the upper airway (including infections of the nose and throat), headache and nausea, as listed below. ORENCIA can cause serious side effects, which may need treatment.

**Possible serious side effects** include serious infections, malignancies (cancer) and allergic reactions, as listed below.

**Tell your doctor immediately** if you notice any of the following:

- severe rash, hives or other signs of allergic reaction
- swollen face, hands or feet
- trouble breathing or swallowing
- fever, persistent cough, weight loss, listlessness

**Tell your doctor as soon as possible** if you notice any of the following:

- feeling generally unwell, dental problems, burning sensation during urination, painful skin rash, painful skin blisters, coughing

The symptoms described above can be signs of the side effects listed below, all of which have been observed with ORENCIA in adult clinical trials:

List of side effects:

**Very common** (may affect more than 1 in 10 people):

- infections of the upper airway (including infections of the nose, throat and sinuses).

**Common** (may affect up to 1 in 10 people):

- infections of lungs, urinary infections, painful skin blisters (herpes), flu
- headache, dizziness
- high blood pressure
- cough
- abdominal pain, diarrhoea, nausea, upset stomach, mouth sores, vomiting
- rash
- fatigue, weakness, injection site reactions
- abnormal liver function tests

**Uncommon** (may affect up to 1 in 100 people):

- tooth infection, nail fungal infection, infection in the muscles, blood stream infection, collection of pus under the skin, kidney infection, ear infection
- low white blood cells count
- skin cancer, skin warts
- low blood platelet count
- allergic reactions
- depression, anxiety, sleep disturbance
- migraine
- numbness
- dry eye, reduced vision
- eye inflammation
- palpitation, rapid heart rate, low heart rate
- low blood pressure, hot flush, blood vessels inflammation, flushing
- difficulty in breathing, wheezing, shortness of breath, acute worsening of a lung disease called chronic obstructive pulmonary disease (COPD)
- throat tightness
- rhinitis
- increased tendency to bruise, dry skin, psoriasis, skin redness, excessive sweating, acne
- hair loss, itching, hives
- painful joints
- pain in the extremities
- absence of menstruation, excessive menses
- flu-like illness, increased weight

**Rare** (may affect up to 1 in 1,000 people):

- tuberculosis
- inflammation of uterus, fallopian tubes and/or ovaries
- gastrointestinal infection

- cancer of white blood cells, lung cancer

#### Children and adolescents with polyarticular juvenile idiopathic arthritis

The side effects experienced in children and adolescents with polyarticular juvenile idiopathic arthritis are similar to those experienced in adults as described above with the following differences:

**Common** (may affect up to 1 in 10 people):

- upper airway infection (including infections of nose, sinus and throat)
- fever

**Uncommon** (may affect up to 1 in 100 people):

- blood in urine
- ear infection

#### Reporting of side effects

If you get any side effects, talk to your doctor, pharmacist or nurse. This includes any possible side effects not listed in this leaflet. You can also report side effects directly (see details below). By reporting side effects you can help provide more information on the safety of this medicine.

#### **Ireland**

HPRA Pharmacovigilance

Website: [www.hpra.ie](http://www.hpra.ie)

#### **Malta**

ADR Reporting

Website: [www.medicinesauthority.gov.mt/adrportal](http://www.medicinesauthority.gov.mt/adrportal)

#### **United Kingdom**

Yellow Card Scheme

Website: at: [www.mhra.gov.uk/yellowcard](http://www.mhra.gov.uk/yellowcard) or search for MHRA Yellow Card in the Google Play or Apple App Store

### **5. How to store ORENCIA**

Keep this medicine out of the sight and reach of children.

Do not use this medicine after the expiry date which is stated on the label and the carton after EXP. The expiry date refers to the last day of that month.

Store in a refrigerator (2°C to 8°C). Do not freeze.

Store in the original package in order to protect from light.

Do not use this medicine if the liquid is cloudy or discoloured, or has large particles. The liquid should be clear to pale yellow.

Do not throw away any medicines via wastewater or household waste. Ask your pharmacist how to throw away medicines you no longer use. These measures will help to protect the environment.

## 6. Contents of the pack and other information

### What ORENCIA contains

#### ORENCIA 50 mg solution for injection in pre-filled syringe

- The active substance is abatacept.
- Each pre-filled syringe contains 50 mg of abatacept in 0.4 mL.

#### ORENCIA 87.5 mg solution for injection in pre-filled syringe

- The active substance is abatacept.
- Each pre-filled syringe contains 87.5 mg of abatacept in 0.7 mL.

#### ORENCIA 125 mg solution for injection in pre-filled syringe

- The active substance is abatacept.
- Each pre-filled syringe contains 125 mg of abatacept in one mL.
  
- The other ingredients are sucrose, poloxamer 188, sodium dihydrogen phosphate monohydrate, disodium phosphate anhydrous, and water for injections (see section 2 "ORENCIA contains sodium").

### What ORENCIA looks like and contents of the pack

ORENCIA solution for injection (injection) is a clear, colourless to pale yellow solution.

ORENCIA is available in the following presentations:

#### ORENCIA 50 mg solution for injection in pre-filled syringe with white plunger

- pack of 4 pre-filled syringes with needle guard.

#### ORENCIA 87.5 mg solution for injection in pre-filled syringe with light blue plunger

- pack of 4 pre-filled syringes with needle guard.

#### ORENCIA 125 mg solution for injection in pre-filled syringe with orange plunger

- packs of 1 or 4 pre-filled syringes and multipack containing 12 pre-filled syringes (3 packs of 4).
- packs of 1, 3, or 4 pre-filled syringes with needle guard and multipack containing 12 pre-filled syringes with needle guard (3 packs of 4).

Not all pack sizes may be marketed.

### Marketing Authorisation Holder

Bristol-Myers Squibb Pharma EEIG  
Plaza 254  
Blanchardstown Corporate Park 2  
Dublin 15, D15 T867  
Ireland

### Manufacturer

Swords Laboratories t/a Bristol-Myers Squibb Cruiserath Biologics  
Cruiserath Road, Mulhuddart  
Dublin 15  
Ireland

For any information about this medicine, please contact the local representative of the Marketing Authorisation Holder:

**Ireland**

Bristol-Myers Squibb Pharmaceuticals uc  
Tel: + 353 (0)1 483 3625

**Malta**

Bristol-Myers Squibb S.r.l.  
Tel: + 356 23976333

**United Kingdom**

Bristol-Myers Squibb Pharmaceuticals Ltd  
Tel: + 44 (0800) 731 1736

**This leaflet was last revised in September 2020**

**Other sources of information**

Detailed information on this medicine is available on the European Medicines Agency web site:  
<http://www.ema.europa.eu>.



**Important instructions for use. Read carefully.**

**HOW TO USE**

ORENCIA 50 mg

ORENCIA 87.5 mg

ORENCIA 125 mg

solution for injection in pre-filled syringe with needle guard

Abatacept

Subcutaneous use

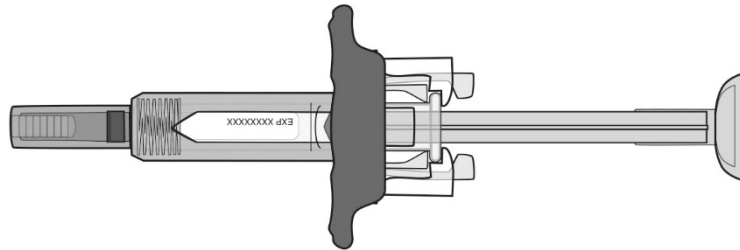

**Read these instructions before you use the ORENCIA pre-filled syringe.**

Before you use the pre-filled syringe for the first time, make sure your doctor, nurse or pharmacist shows you the right way to use it.

**Keep refrigerated until ready to use. DO NOT FREEZE.**

**If you have questions about this product, please read the Package Leaflet.**

**BEFORE YOU BEGIN:**

**Get to know your Pre-filled Syringe**

There are 3 types of pre-filled syringes:

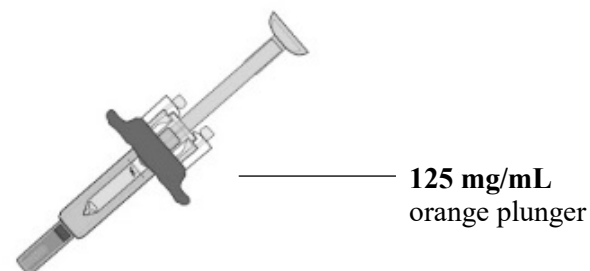
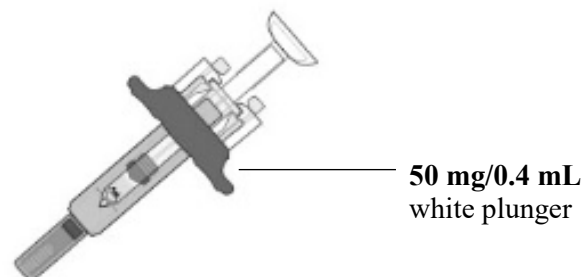

The type of pre-filled syringe you receive depends on the dose prescribed by your doctor. The 125 mg/mL pre-filled syringe is shown below.

## Before Use

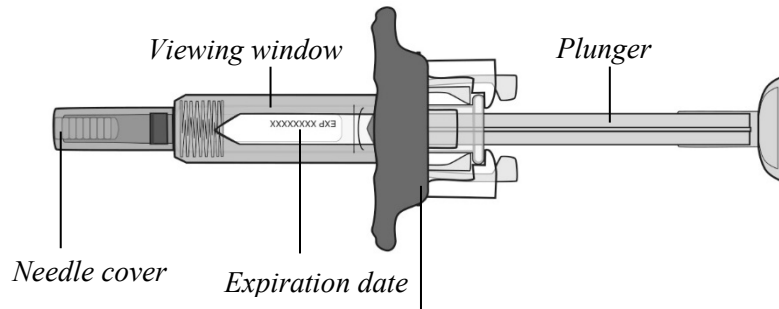

## After Use

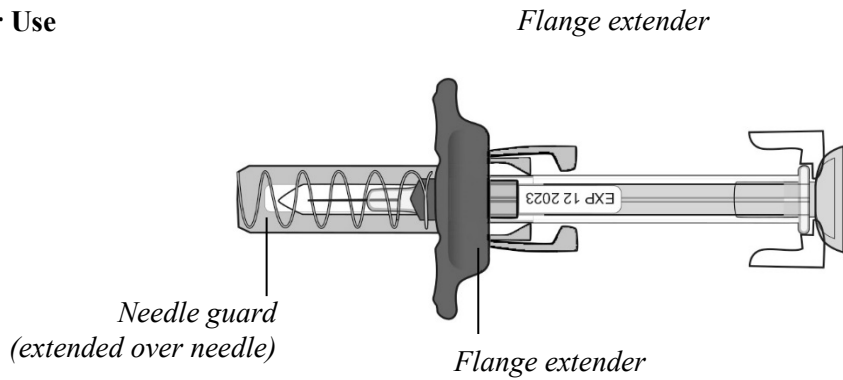

The pre-filled syringe has a **flange extender** that makes it easier to hold and inject, and a **needle guard** that automatically covers the needle after a complete injection.



**DO NOT** remove the needle cover until you are ready to inject.

**DO NOT PULL** back the plunger at any time.

**DO NOT RECAP** the pre-filled syringe at any time, as this may damage, bend, or break the needle. Always hold the syringe by its body.

Proceed to Step 1

### Step 1: Preparing for an ORENCIA Injection

**Gather supplies for your injection on a clean, flat surface.**

Only the pre-filled syringe is included in the package:

- Alcohol swab



- Adhesive plaster

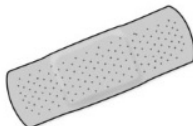

- Cotton ball or gauze



- Pre-filled syringe with UltraSafe Passive Needle guard

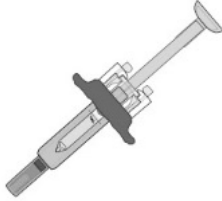

- Sharps disposal container

### Let your Pre-filled syringe warm up.

Remove one pre-filled syringe from the refrigerator and wait **30 minutes** to allow it to reach room temperature.

- **Do not** speed up the warming process in any way, such as using the microwave or placing the syringe in warm water.
- **Do not** remove the needle cover while allowing the pre-filled syringe to reach room temperature.

Wait

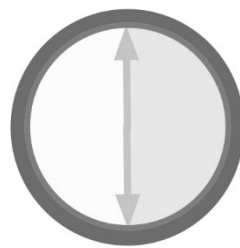

**30 Minutes**

**Wash your hands well with soap and water to prepare for injection.**

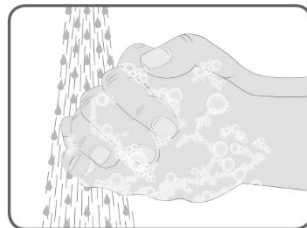

Proceed to Step 2

### Step 2: Examine the Pre-filled syringe

Hold the pre-filled syringe by the body with the needle cover pointing down as shown.

- Check the expiry date printed on the label.  
**Do not** use if the expiry date has passed.
- Check the pre-filled syringe for damage.  
**Do not** use if it is cracked or broken.

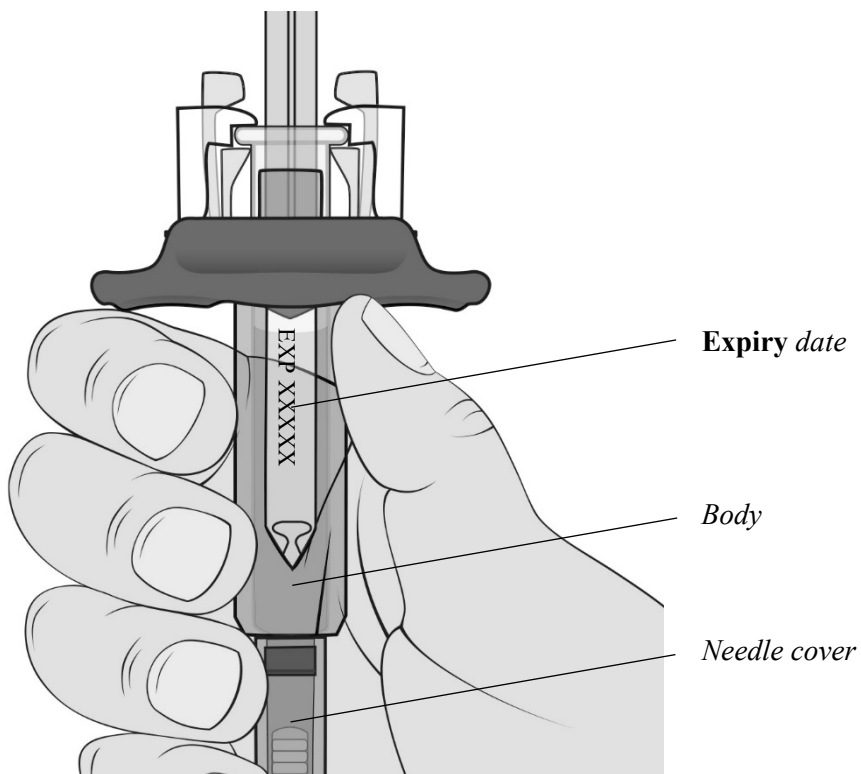

**Check the liquid**

**Check the liquid** in the pre-filled syringe through the viewing window. It should be clear and colourless to pale yellow.

You may see a small air bubble. **Do not** attempt to remove it.

**Do not inject if the liquid is cloudy, discoloured, or has particles.**

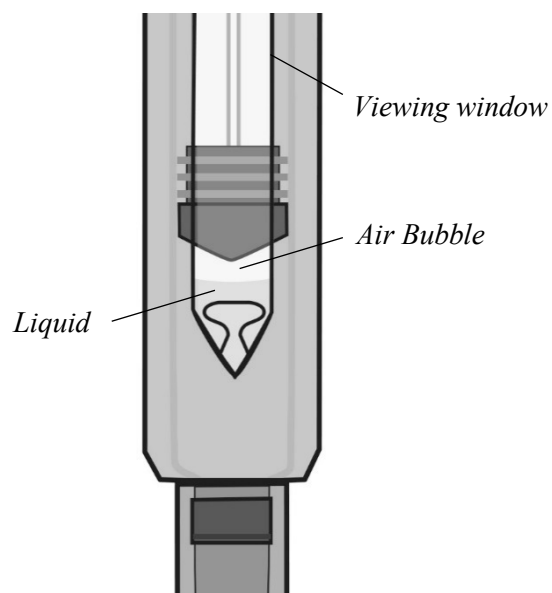

\*Note: the figure shows the 50 mg pre-filled syringe

Proceed to Step 3

### Step 3: Check the Dose on the Pre-filled Syringe

Hold the syringe at eye level. Look closely to make sure that the amount of liquid in the pre-filled syringe is **at or just above the fill line** for your prescribed dose:

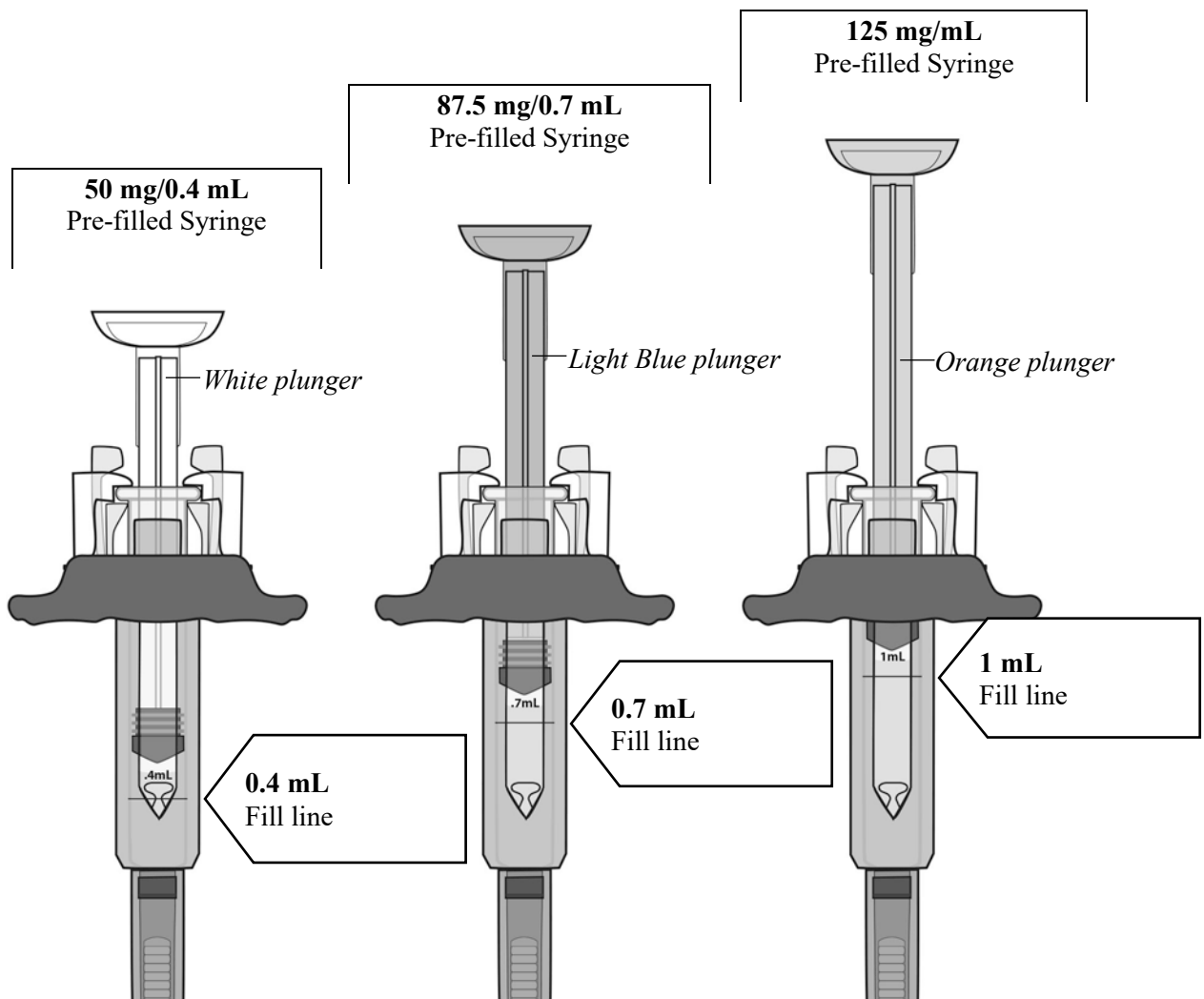

**Do not** use if your pre-filled syringe does not have the correct amount of liquid. Contact your doctor, nurse, or pharmacist for further instructions.

Proceed to Step 4

#### Step 4: Choose and Prepare an Injection Site

Choose your injection site in either the **abdomen**, front of the **thighs**, or outer area of **upper arm** (only if caregiver administered).

##### Change injection site

- Each week you can use the same area of your body, but use a different injection site in that area.
- **Do not** inject into an area where the skin is tender, bruised, red, scaly, or hard.
- **Do not** give the injection in any areas with scars or stretch marks.
- Record the date, time, and site where you inject.

##### Injection Areas Self-Injection and Caregiver

*Abdomen, avoid 5 cm around  
navel*

*Front of thighs*

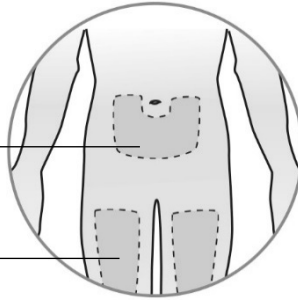

##### Caregiver ONLY

*Outer area of upper arms*

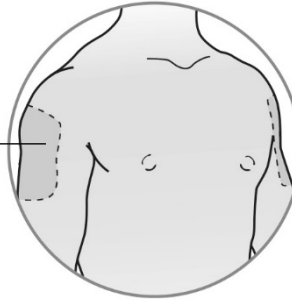

##### Gently clean injection site

- Wipe the injection site with an alcohol swab and let your skin dry.
- **Do not** touch the injection site again before giving the injection.
- **Do not** fan or blow on the clean area.

**Remove the needle cover** by holding the body of the pre-filled syringe with one hand and pulling the cover straight off with your other hand.

**Do not put the needle cover back on the needle after you remove it.** You can discard the cap in your household waste after the injection.

- **Do not** use the pre-filled syringe if it is dropped after the needle cover is removed.
- **Do not** use the pre-filled syringe if the needle is damaged or bent.

Note: It is normal to see a drop of fluid leaving the needle.

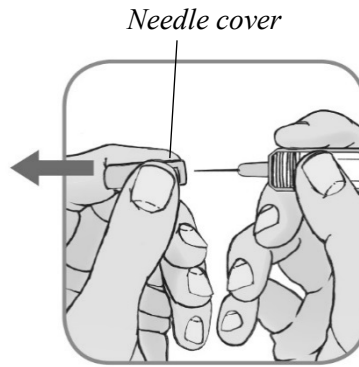

**DO NOT RECAP** the Pre-filled Syringe, as this may damage the needle.

Proceed to Step 5

### Step 5: Inject Your Dose of ORENCIA

**Hold the body** of the pre-filled syringe in your hand using your thumb and index finger. With your other hand, **pinch the cleaned skin**.

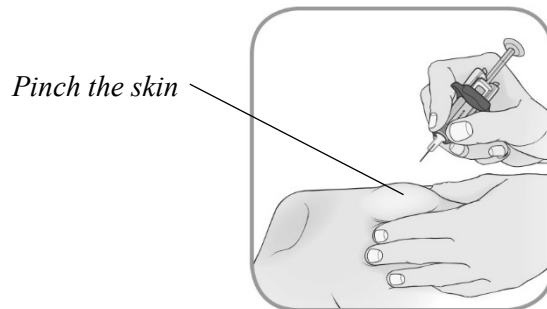

### Insert the needle

**Gently insert** the needle into the pinched skin at a 45° angle.



**Complete ALL steps to deliver your full dose of the medicine**

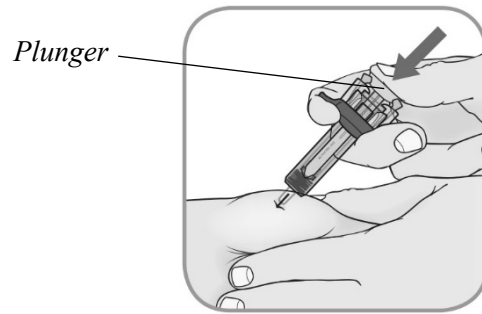

**Inject:** push the plunger with your thumb as far as it will go.

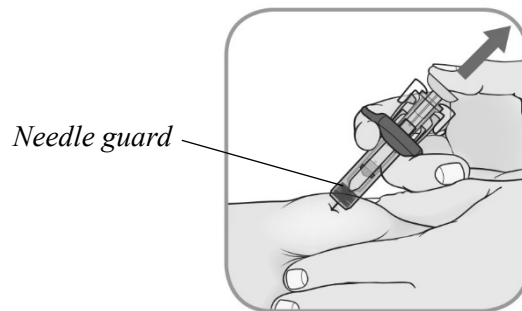

**Release Needle Guard:** slowly lift your thumb from the plunger to activate the needle guard.

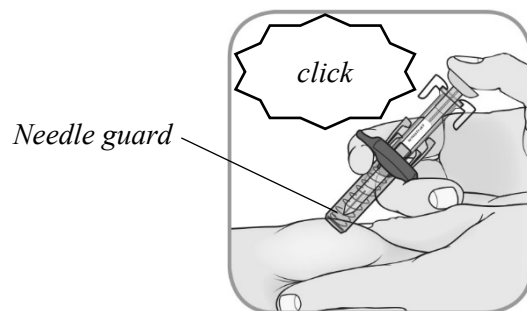

**Confirm:** after a complete injection, the needle guard will cover the needle and you may hear a click.

**Remove the pre-filled syringe** from the injection site and let go of the pinched skin.

Proceed to Step 6



### Step 6: After the Injection

#### Care of injection site:

- There may be a little bleeding at the injection site. You can press a cotton ball or gauze over the injection site.
- **Do not** rub the injection site.
- If needed, you may cover the injection site with an adhesive plaster.

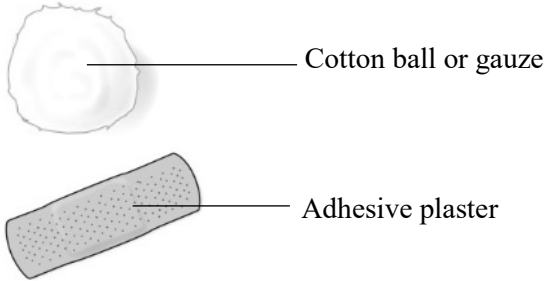

**Dispose of the used pre-filled syringe** into sharps disposal container right away after use. Should you have any questions, ask your pharmacist.

See the **Package Leaflet** for additional disposal information.

If your injection is administered by a caregiver, this person must also handle the syringe carefully to prevent accidental needle stick injury and possibly spreading infection.

**Keep this medicine and the disposal container out of the sight and reach of children.**

### Important instructions for use

Please read these instructions carefully and follow them step by step.

You will be trained by your doctor or nurse on how to self-inject ORENCIA using the pre-filled syringe.

Don't try to self-inject until you are sure that you understand how to prepare and give the injection. After proper training, you can give the injection to yourself, or it can be given by another person, for example a family member or friend.

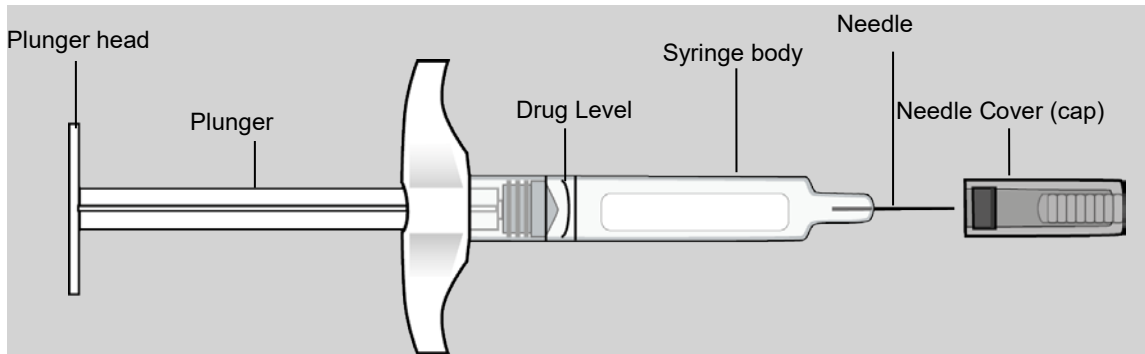

Figure 1

### Before you start - some Do's and Don'ts

#### Do

- ✓ Always handle the ORENCIA syringe carefully, especially when you are around other people, and children.
- ✓ Always hold the syringe by its body.
- ✓ Store unused syringes in the refrigerator in the original carton.
- ✓ Have your additional injection supplies ready before you inject.
  - ☑ **Supplies checklist:** alcohol swabs, cotton ball or gauze, adhesive plaster, Sharps container. Sharps containers are special puncture-resistant disposal bins that can be bought at many retail outlets.

#### Don't

- ✗ **Don't** remove the needle cover (cap) until you are ready to inject.
- ✗ **Don't** pull back on the plunger at any time.
- ✗ **Don't** shake the syringe, as this may damage the ORENCIA medicine.
- ✗ **DON'T** recap the needle.

### STEP 1: Get the syringe ready

#### A. Check the expiry date and batch number on the carton

- The expiry date can be found on the ORENCIA carton and on each syringe.
- If the expiry date has passed, do not use the syringes. Contact your doctor or pharmacist for assistance.

#### B. Let the syringe warm up

- Find a comfortable space with a clean, flat, working surface.
- Remove the syringe from the refrigerator. Keep any remaining unused syringes in their original carton, in the refrigerator.
- Check that the expiry date and batch number match the ones on the carton.
- Inspect the syringe for obvious flaws, but **don't** remove the needle cover.

- Allow the syringe to rest at room temperature for 30 to 60 minutes before you inject.
  - ✗ **Don't** speed the warming process in any way, such as using the microwave or placing the syringe in warm water.

**C. Check the liquid in the syringe**

- Hold the syringe by its body, with the covered needle pointing down.

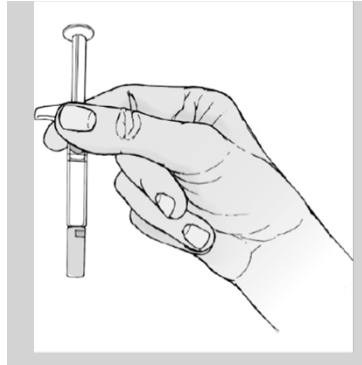

**Figure 2**

- Look at the liquid in the syringe (Figure 2). The liquid should be clear to pale yellow.
  - ✗ **Don't** inject if the liquid is cloudy or discoloured, or has visible particles.
- It is normal to see an air bubble, and there is no reason to remove it. All contents of the syringe should be injected.

**D. Gather your additional supplies and keep them within easy reach.**

**E. Wash your hands thoroughly with soap and warm water.**

**STEP 2: Choose and prepare your injection site**

Have the syringe ready for use immediately after you have prepared your injection site.

**A. Choose an area of your body for the injection (injection site)**

- You can use:
  - the front of your thigh
  - your abdomen, except for the 5 cm area around the navel (Figure 3).

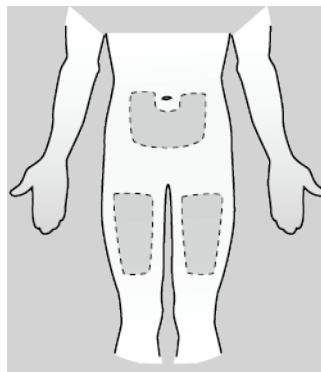

**Figure 3**

- Choose a different injection site for each new injection. You may use the same thigh for weekly injections, as long as each injection site is approximately 2.5 cm away from where you last injected.
  - ✗ **Don't** inject into areas where your skin is tender, bruised, red, scaly, or hard. Avoid any areas with scars or stretch marks.

**B. Prepare your injection site**

- Wipe your injection site with an alcohol swab in a circular motion.
- Let your skin dry before injecting.
  - × **Don't** touch your injection site again before giving the injection.
  - × **Don't** fan or blow on the clean area.

**STEP 3: Inject ORENCIA**

**A. Remove the needle cover (cap) only when you are ready to administer the injection.**

- Hold the syringe by its body in one hand, and pull the needle cover straight off with your other hand (Figure 4).

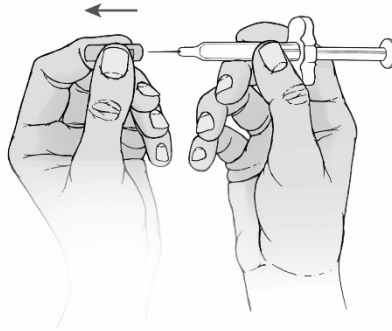

**Figure 4**

There may be a small air bubble in the liquid in the syringe. There is no need to remove the air bubble.

You may notice a drop of fluid leaving the needle. This is normal and will not affect your dose.

- × **Don't** touch the plunger while you remove the needle cover.
- × **Don't** remove the needle cover until you are ready to inject ORENCIA.
- × **Don't** touch the needle or let it touch any surfaces.
- × **Don't** use the syringe if it is dropped without the needle cover in place.
- × **Don't** put the needle cover back on the needle once removed.
- × **Don't** use the syringe if there are visible signs of needle damage or bending.

## B. Position the syringe and inject ORENCIA

- Hold the syringe by its body in one hand between your thumb and index finger (Figure 5).
  - ✗ **Don't** press on the plunger head until you begin your injection.
  - ✗ **Don't** pull back on the plunger at any time.
- Using your other hand, gently pinch the area of skin you cleaned. Hold it firmly.
- Insert the needle with a quick motion into the pinched skin at a 45° angle (Figure 5).

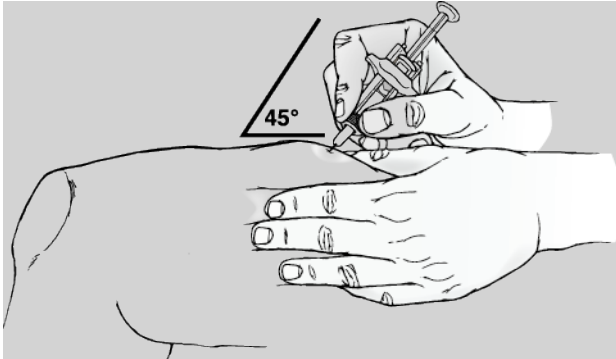

Figure 5

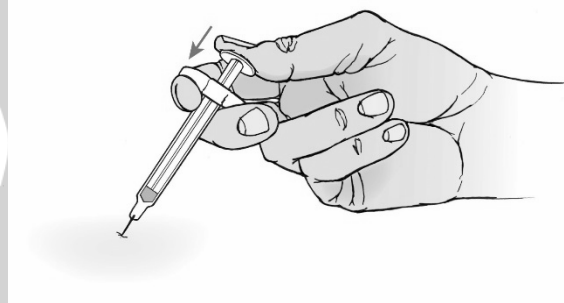

Figure 6

- Use your thumb to push the plunger down, pressing firmly until the plunger will go no further, and all of the medicine has been injected (Figure 6).
- Remove the needle from the skin and let go of the surrounding skin.
  - ✗ **DON'T** recap the needle.
- Press a cotton ball over the injection site and hold for 10 seconds.
  - ✗ **Don't** rub the injection site. Slight bleeding is normal.
- If needed, you may apply a small adhesive plaster to the injection site.

## STEP 4: Dispose of the syringe and keep a record

### A. Dispose of the used syringe in a Sharps container.

- Ask your doctor, nurse, or pharmacist about national and local laws regarding the proper disposal of medical products that contain needles.
- ✓ **Always** keep your Sharps container out of reach of children and animals.
- ✗ **Don't** throw away used syringes in your household rubbish or recycling bins.

### B. Keep a record of your injection

- Write down the date, time, and specific part of your body where you injected yourself. It may also be helpful to write down any questions or concerns about the injection so you can ask your doctor, nurse or pharmacist.

Medicines should not be disposed of via wastewater or household waste. Ask your pharmacist how to dispose of medicines no longer required. These measures will help to protect the environment.