

## **Package leaflet: Information for the user**

### **Icatibant 30 mg solution for injection in pre-filled syringe** icaticbant

**Read all of this leaflet carefully before you start using this medicine because it contains important information for you.**

- Keep this leaflet. You may need to read it again.
- If you have any further questions, ask your doctor or pharmacist.
- This medicine has been prescribed for you only. Do not pass it on to others. It may harm them, even if their signs of illness are the same as yours.
- If you get any side effects, talk to your doctor or pharmacist. This includes any possible side effects not listed in this leaflet. See section 4.

#### **What is in this leaflet**

1. What Icatibant Solution for Injection is and what it is used for
2. What you need to know before you use Icatibant Solution for Injection
3. How to use Icatibant Solution for Injection
4. Possible side effects
5. How to store Icatibant Solution for Injection
6. Contents of the pack and other information

#### **1. What Icatibant Solution for Injection is and what it is used for**

Icatibant Solution for Injection contains the active substance icaticbant.

This medicine is used for treating the symptoms of hereditary angioedema (HAE) in adults, adolescents and children aged 2 years and older.

In HAE levels of a substance in your bloodstream called bradykinin are increased and this leads to symptoms like swelling, pain, nausea, and diarrhoea.

Icatibant Solution for Injection blocks the activity of bradykinin and therefore ends the further progression of the symptoms.

#### **2. What you need to know before you use Icatibant Solution for Injection**

##### **Do not use Icatibant Solution for Injection**

- if you are allergic to icaticbant, or any of the other ingredients of this medicine (listed in section 6).

##### **Warnings and precautions**

Talk to your doctor before taking Icatibant Solution for Injection:

- if you are suffering from angina (reduced blood flow to the heart muscle)
- if you have recently suffered a stroke

Some of the side effects connected with Icatibant Solution for Injection are similar to the symptoms of your disease. Tell your doctor immediately if you notice that your symptoms of the attack get worse after you received this medicine.

In addition:

- You or your caregiver must be trained on subcutaneous (under the skin) injection technique before you self-inject or your caregiver injects you with this medicine.

- Immediately after you self-inject Icatibant Solution for Injection or your caregiver injects you with this medicine while you are experiencing a laryngeal attack (obstruction of the upper airway), you must seek medical care in a medical institution.
- If your symptoms are not resolved following one self- or caregiver administered injection of icatibant, ask your doctor regarding additional injections of this medicine. For adult patients, up to 2 additional injections may be given within 24 hours.

### **Children and adolescents**

This medicine is not recommended for use in children under 2 years of age or weighing less than 12 kg because it has not been studied in these patients.

### **Other medicines and Icatibant Solution for Injection**

Tell your doctor if you are taking, have recently taken or might take any other medicines.

Icatibant Solution for Injection is not known to interact with other medicines. If you are taking a medicine known as an Angiotensin Converting Enzyme (ACE) inhibitor (for example: captopril, enalapril, ramipril, quinapril, lisinopril) which is used to lower your blood pressure or for any other reason, ask your doctor before receiving this medicine.

### **Pregnancy and breast-feeding**

If you are pregnant or breast-feeding, think you may be pregnant or are planning to have a baby, ask your doctor before starting to use this medicine.

If you are breast-feeding you should not breast-feed for 12 hours after you have last received this medicine.

### **Driving and using machines**

Do not drive or use machines if you feel tired or dizzy as a result of your HAE attack or after using this medicine.

### **Icatibant Solution for Injection contains sodium**

The injection solution contains less than 1 mmol (23 mg) of sodium, so it is essentially 'sodium-free'.

## **3. How to use Icatibant Solution for Injection**

Always use this medicine exactly as your doctor has told you. Check with your doctor if you are not sure.

If you have never received Icatibant Solution for Injection previously, your first dose of Icatibant Solution for Injection will always be injected by your doctor or nurse. Your doctor will tell you when it is safe for you to go home.

After discussion with your doctor or nurse and after training in subcutaneous (under the skin) injection technique, you may be able to inject yourself with Icatibant Solution for Injection or your caregiver may inject this medicine for you when you have an HAE attack.

It is important that Icatibant Solution for Injection is injected subcutaneously (under the skin) as soon as you notice an attack of angioedema. Your healthcare provider will teach you and your caregiver how to safely inject this medicine by following the instructions in the Package Leaflet.

### **When and how often to use Icatibant Solution for Injection**

Your doctor has determined the exact dose of this medicine and will tell you how often it should be used.

## Adults

- The recommended dose of icatibant is one injection (3 ml, 30 mg) injected subcutaneously (under the skin) as soon as you notice the attack of angioedema (for example increased skin swelling, particularly affecting the face and neck, or increasing tummy pain).
- If you experience no relief of symptoms after 6 hours, you should ask your doctor regarding additional injections of icatibant. For adults, up to 2 additional injections may be given within 24 hours.
- **Do not have more than 3 injections in a 24-hour period and if you require more than 8 injections in a month, you should talk to your doctor.**

## Children and adolescents aged 2 to 17 years

- The recommended dose of Icatibant Solution for Injection is one injection of 1 ml up to a maximum of 3 ml based on body weight injected subcutaneously (under the skin) as soon as you develop symptoms of an angioedema attack (for example increased skin swelling, particularly affecting the face and neck, increasing tummy pain).
- See section on instructions for use for the dose to inject.
- If you are not sure which dose to inject, ask your doctor, pharmacist or nurse.
- **If your symptoms get worse or do not improve, you must immediately seek medical help.**

## Icatibant Solution for Injection administration?

Icatibant Solution for Injection is intended for subcutaneous injection (under the skin). Use each syringe only once.

This medicine is injected with a short needle into the fatty tissue under the skin in the abdomen (tummy).

If you have any further questions on the use of this medicine, ask your doctor or pharmacist.

## The following step-by step instructions are intended for:

- **self-administration (adults)**
- **administration by a caregiver or healthcare professional to adults, adolescents or children aged over 2 years (weighing at least 12 kg).**

The instructions include the following main steps:

- 1) General information
- 2a) Preparing the syringe for children and adolescents (2-17 years) weighing 65 kg or less
- 2b) Preparing the syringe and needle for injection (all patients)
- 3) Preparing the injection site
- 4) Injecting the solution
- 5) Disposal of the injection material

## Step-by-Step Instructions for Injection

### 1) General information

- Clean the work area (surface) to be used before beginning the process.
- Wash your hands with soap and water.
- Remove the pre-filled syringe from the carton.
- Remove the cap from the end of the pre-filled syringe by unscrewing the cap.
- Put down the pre-filled syringe after unscrewing the cap.

## 2a) Preparing the syringe for children and adolescents (2-17 years) weighing 65 kg or less:

### Important information for healthcare professionals and caregivers:

Where the dose is less than 30 mg (3 ml), the following equipment is required to extract the appropriate dose (see below):

- a) Icatibant Solution for Injection pre-filled syringe (containing icatibant solution)
- b) Connector (adapter)
- c) 3 ml graduated syringe

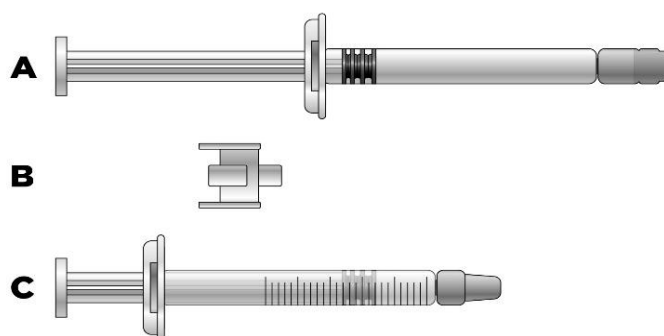

The required injection volume in ml should be drawn up in an empty 3 ml graduated syringe (see table below).

**Table 1: Dosage regimen for children and adolescents**

| Body Weight    | Injection Volume |
|----------------|------------------|
| 12 kg to 25 kg | 1.0 ml           |
| 26 kg to 40 kg | 1.5 ml           |
| 41 kg to 50 kg | 2.0 ml           |
| 51 kg to 65 kg | 2.5 ml           |

Patients weighing **more than 65 kg** will use the full contents of the pre-filled syringe (3 ml).



**If you are not sure which volume of solution to extract, ask your doctor, pharmacist or nurse**

- 1) Remove the caps on each end of the connector.



**Avoid touching the ends of the connector and syringe tips, to prevent contamination**

- 2) Screw the connector onto the pre-filled syringe.
- 3) Attach the graduated syringe to the other end of the connector ensuring that both connections fit

securely.

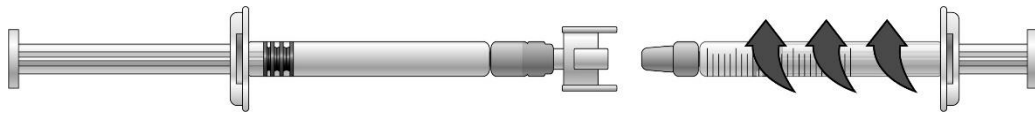

**Transferring the icatibant solution to the graduated syringe:**

1) To start transfer of icatibant solution, push the pre-filled syringe plunger (on far left of below image).

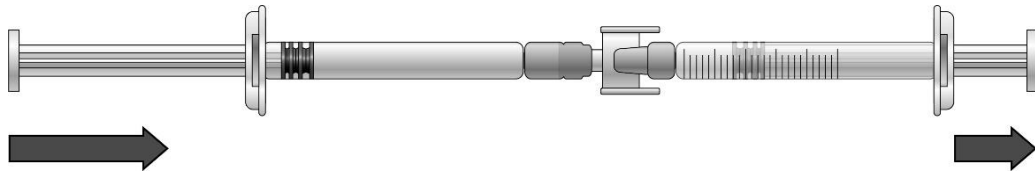

2) If the icatibant solution does not begin to transfer to the graduated syringe, pull slightly on the graduated syringe plunger until the icatibant solution starts to flow into the graduated syringe (see below image).

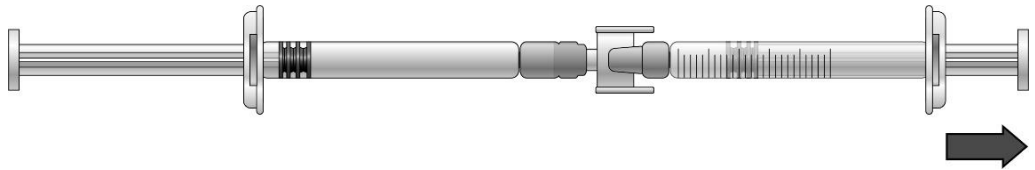

3) Continue to push on the pre-filled syringe plunger until the required injection volume (dose) is transferred to the graduated syringe. Refer to table 1 for dosage information.

**If there is air in the graduated syringe:**

- Turn the connected syringes so that the pre-filled syringe is on top (see below image).

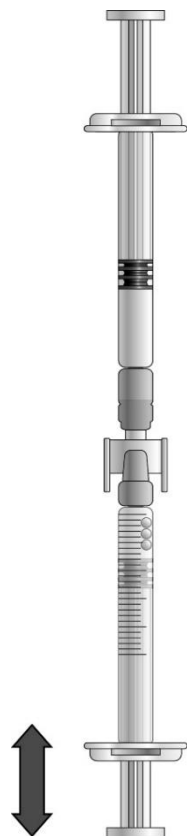

- Push the plunger of the graduated syringe so that any air is transferred back into the pre-filled syringe (this step may need to be repeated several times).
- Withdraw the required volume of icatibant solution.

4) Remove the pre-filled syringe and connector from the graduated syringe.

5) Discard the pre-filled syringe and connector into the sharps container.

**2b) Preparing the syringe and needle for injection: All patients  
(adults, adolescents and children)**



- Remove the needle cap from the blister.
- Remove the seal from the needle cap (the needle should be still in the needle cap).

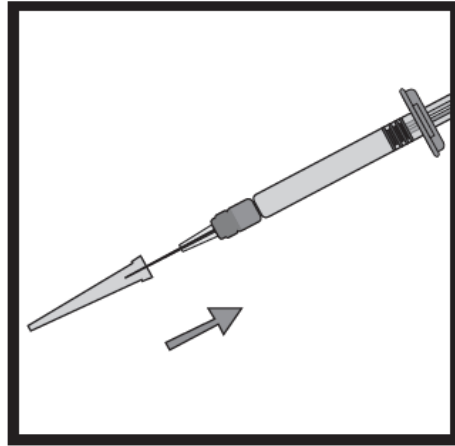

- Grip the syringe firmly. Carefully attach the needle to the syringe containing the colourless solution.
- Screw the syringe on the needle still fixed in the needle cap.
- Remove the needle from the needle cap by pulling the syringe. Do not pull up on the plunger.
- The syringe is now ready for injection.

### 3) Preparing the injection site



- Choose the injection site. The injection site should be a skin fold on your abdomen approximately 5-10 cm (2-4 inches) below your navel on either side. This area should be at least 5 cm (2 inches) away from any scars. Do not choose an area that is bruised, swollen, or painful.
- Clean the injection site with a rubbing alcohol pad and allow it to dry.

### 4) Injecting the solution

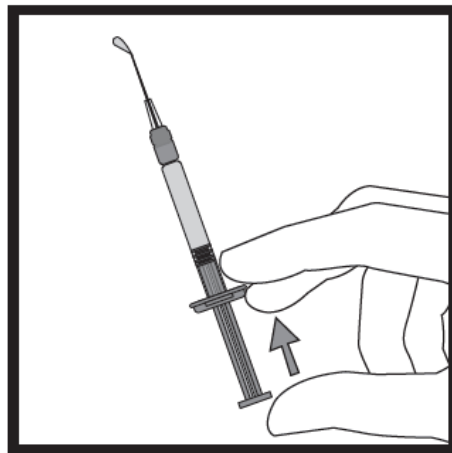

- Hold the syringe in one hand between two fingers with your thumb at the bottom of the plunger.
- Make sure that there is no air bubble in the syringe by pressing the plunger until the first drop appears on the tip of the needle.



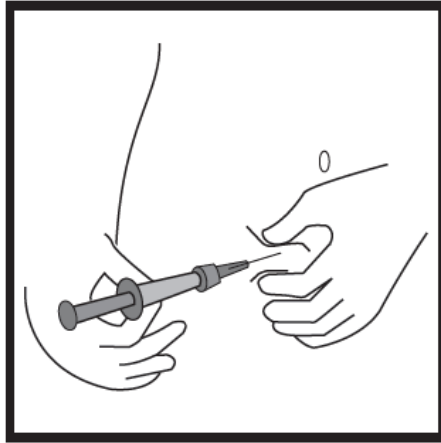

- Hold syringe between 45-90 degrees angle to skin with needle facing the skin.
- Keeping the syringe in one hand, use your other hand to gently hold a fold of skin between your thumb and fingers at the previously disinfected injection site.
- Hold the fold of skin, bring the syringe to the skin and quickly insert the needle into the skin fold.
- Slowly push the plunger of the syringe with a steady hand until all the fluid is injected into the skin and no liquid remains in the syringe.
- Press slowly so that this takes approximately 30 seconds.
- Release the skin fold and gently pull the needle out.

### 5) Disposal of the injection material

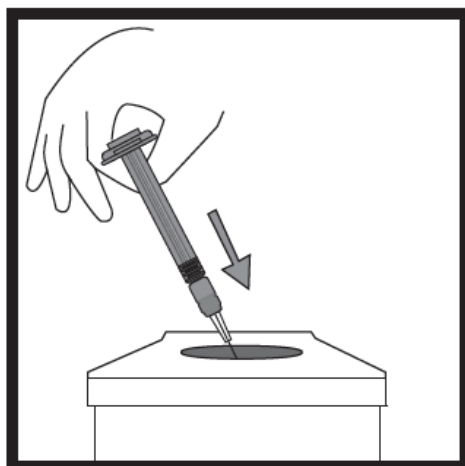

- Discard the syringe, needle and needle cap into the sharps container for throwing away waste that might hurt others if not handled properly.

#### 4. Possible side effects

Like all medicines, this medicine can cause side effects, although not everybody gets them.

Almost all patients receiving Icatibant Solution for Injection will experience a reaction at the site of the injection (such as skin irritation, swelling, pain, itchiness, redness of the skin and burning sensation). These effects are usually mild and clear up without the need for any additional treatment.

Tell your doctor immediately if you notice that the symptoms of your attack get worse after you received Icatibant Solution for Injection.

**Very common** (may affect more than 1 in 10 people):

- Additional injection site reactions (pressure sensation, bruising, reduced sensation and/or numbness, raised itchy skin rash and warmth).

**Common** (may affect up to 1 in 10 people):

- Feeling sick
- Headache
- Dizziness
- Fever
- Itching
- Rash
- Skin redness
- Abnormal liver function test

**Not known** (frequency cannot be estimated from the available data):

- Hives (urticaria)

#### Reporting of side effects

If you get any side effects, talk to your doctor or pharmacist. This includes any possible side effects not listed in this leaflet. You can also report side effects directly via the Yellow Card Scheme at: <https://yellowcard.mhra.gov.uk/> or search for MHRA Yellow Card in the Google Play or Apple App Store. By reporting side effects, you can help provide more information on the safety of this medicine.

#### 5. How to store Icatibant Solution for Injection

Keep this medicine out of the sight and reach of children.

Do not use this medicine after the expiry date stated on the label and box after 'EXP'. The expiry date refers to the last day of that month.

Do not store above 25°C. Do not freeze.

Do not use this medicine if you notice that the syringe or needle packaging is damaged or if there are any visible signs of deterioration, for example if the solution is cloudy, if it has floating particles, or if the colour of the solution has changed.

Do not throw away any medicines via waste water or household waste. Ask your pharmacist how to throw away medicines you no longer use. These measures will help protect the environment.

## **6. Contents of the pack and other information**

### **What Icatibant Solution for Injection contains**

- The active substance is icatibant. Each pre-filled syringe contains 30 milligrams of icatibant (as acetate). Each ml of the solution contains 10 mg of icatibant.
- The other ingredients are: sodium chloride, acetic acid glacial (for ph adjustment), sodium hydroxide (for ph adjustment), and water (see section 2).

### **What Icatibant Solution for Injection looks like and contents of the pack**

Icatibant Solution for Injection is presented as a clear, colourless solution for injection in a pre-filled glass syringe of 3 ml. A hypodermic needle is included in the pack.

Icatibant Solution for Injection is available as a single pack containing one pre-filled syringe with one needle or as a multipack containing three pre-filled syringes with three needles.

Not all pack sizes may be marketed.

### **Marketing Authorisation Holder**

Cipla (EU) Limited  
Dixcart House,  
Addlestone Road, Bourne Business Park, Addlestone  
Surrey KT15 2LE  
United Kingdom

### **Manufacturer**

**Pharmadox Healthcare Ltd.**  
KW20A Kordin Industrial Park  
Paola PLA 3000 Malta

**Eurofins PROXY Laboratories B.V.**  
Archimedesweg 25 2333 CM Leiden  
The Netherlands

**This leaflet was last revised in 11/2023**