

Package leaflet: Information for the patient

wegovy FlexTouch 0.25 mg, 0.5 mg, 1 mg, 1.7 mg and 2.4 mg solution for injection in pre-filled pen semaglutide

▼ This medicine is subject to additional monitoring. This will allow quick identification of new safety information. You can help by reporting any side effects you may get. See the end of section 4 for how to report side effects.

Read all of this leaflet carefully before you start using this medicine because it contains important information for you.

- Keep this leaflet. You may need to read it again.
- If you have any further questions, ask your doctor, pharmacist or nurse.
- This medicine has been prescribed for you only. Do not pass it on to others. It may harm them, even if their signs of illness are the same as yours.
- If you get any side effects, talk to your doctor, pharmacist or nurse. This includes any possible side effects not listed in this leaflet. See section 4.

What is in this leaflet

1. What wegovy is and what it is used for
2. What you need to know before you use wegovy
3. How to use wegovy
4. Possible side effects
5. How to store wegovy
6. Contents of the pack and other information

1. What wegovy is and what it is used for

What wegovy is

wegovy is a medicine for weight loss and weight maintenance that contains the active substance semaglutide. It is similar to a natural hormone called glucagon-like peptide-1 (GLP-1) that is released from the intestine after a meal. wegovy works by acting on receptors in the brain that control your appetite, causing you to feel fuller and less hungry and experience less craving for food. This will help you eat less food and reduce your body weight. wegovy should be used with a reduced calorie meal plan and increased physical activity.

What wegovy is used for

Weight management

wegovy is used for weight loss and weight maintenance in addition to diet and physical activity in adults, who have:

- a BMI of 30 kg/m² or greater (with obesity) or
- a BMI of 27 kg/m² and less than 30 kg/m² (overweight) and weight-related health problems.

BMI (Body Mass Index) is a measure of your weight in relation to your height.

wegovy is used together with diet and physical activity for weight management in adolescents ages 12 years and above, who have

- obesity
- body weight >60kg

As an adolescent patient, you should only continue using wegovy if you have lost at least 5% of your BMI after 12 weeks on the 2.4 mg dose or maximum tolerated dose (see section 3). Consult your doctor before you continue.

Risk reduction of serious heart issues in adults

wegovy is used in addition to diet and physical activity to reduce the risk of serious heart issues (heart-related death, heart attacks, strokes) in adults with a history of heart disease (like a heart attack, stroke or poor blood flow to the limbs) and either obesity or overweight (BMI ≥ 27 kg/m²).

2. What you need to know before you use wegovy

Do not use wegovy if you are allergic to semaglutide or any of the other ingredients of this medicine (listed in section 6).

Warnings and precautions

Talk to your doctor, pharmacist or nurse before using wegovy or during treatment if you have:

- **Effects on the digestive system**

During treatment with wegovy, you may feel sick (nausea) or be sick (vomiting), or have diarrhoea. These side effects can cause dehydration (loss of fluids). It is important that you drink enough fluids to prevent dehydration. This is especially important if you have kidney problems. Talk to your doctor if you have any questions or concerns.

- **Inflammation of the pancreas**

If you have severe and on-going pain in the stomach area see a doctor straight away as this could be a sign of inflamed pancreas (acute pancreatitis).

- **Diabetes**

wegovy must not be used as a substitute for insulin.

- **Low blood sugar (hypoglycaemia)**

wegovy can cause low blood sugar. Please see section 4 for the warning signs of low blood sugar levels.

If you have diabetes and are taking a sulfonylurea or an insulin with wegovy the risk of getting low blood sugar levels (hypoglycaemia) might increase.

Your doctor may ask you to test your blood sugar levels. This will help your doctor decide if the dose of the sulfonylurea or insulin needs to be changed to reduce the risk of low blood sugar.

- **Diabetic eye disease (retinopathy)**

Fast improvements in blood sugar control may lead to a temporary worsening of diabetic eye disease. If you have diabetic eye disease and experience eye problems while taking this medicine, talk to your doctor.

If you know that you are due to have surgery where you will be under anaesthesia (sleeping), please tell your doctor that you are taking wegovy.

Children and adolescents

The safety and efficacy of wegovy in children below 12 years of age have not been studied and are not recommended for use in this population.

Other medicines and wegovy

Tell your doctor, pharmacist or nurse if you are using, have recently used or might use any other medicines.

Pregnancy and breast-feeding

This medicine should not be used during pregnancy, as it is not known if it may affect your unborn child. Therefore, it is recommended to use contraception while using this medicine. If you wish to become pregnant, you should stop using this medicine at least two months in advance. If you become or are pregnant, think you may be pregnant or are planning to have a baby when using this medicine, talk to your doctor straight away, as your treatment will need to be stopped.

You should not use this medicine if you are breast-feeding, as it is unknown if it passes into breast milk.

Driving and using machines

wegovy is unlikely to affect your ability to drive and use machines. Some patients may feel dizzy when taking wegovy mainly during the first 3 months of treatment (see section 4). If you feel dizzy you should not drive or operate machines until you feel better. If you need any further information, talk to your doctor, pharmacist or nurse.

For diabetics using this medicine in combination with a sulfonylurea or insulin, low blood sugar (hypoglycaemia) may occur which may reduce your ability to concentrate. Do not drive or use machines if you get any signs of low blood sugar. See section 2, 'Warning and precautions' for information on increased risk of low blood sugar and section 4 for the warning signs of low blood sugar. Talk to your doctor for further information.

Sodium content

This medicine contains less than 1 mmol sodium (23 mg) per dose, i.e. essentially 'sodium-free'.

3. How to use wegovy

Always use this medicine exactly as your doctor has told you. Check with your doctor, pharmacist or nurse if you are not sure.

How much to use

Adults

The recommended dose is 2.4 mg once weekly.

Your treatment will start at a low dose which will be gradually increased over 16 weeks of treatment as follows:

- When you first start using wegovy, the starting dose is 0.25 mg once weekly.
- Your doctor will instruct you to gradually increase your dose every 4 weeks until you reach the recommended dose of 2.4 mg once weekly.
- Once you reach the recommended dose of 2.4 mg, do not increase this dose further.

You will be told to follow the table below.

Dose escalation	Weekly dose
Week 1–4	0.25 mg
Week 5–8	0.5 mg
Week 9–12	1 mg
Week 13–16	1.7 mg
From week 17	2.4 mg

Your doctor will assess your treatment on a regular basis.

Adolescents (above 12 years of age)

For adolescents, the same dose escalation schedule as for adults should be applied (see above). The dose should be increased until 2.4 mg (maintenance dose) or maximum tolerated dose has been reached. Weekly doses higher than 2.4 mg are not recommended.

How wegovy is given

wegovy is given as an injection under the skin (subcutaneous injection). Do not inject it into a vein or muscle.

- The best places to give the injection are the upper arms, stomach or upper legs.
- Before you use the pen for the first time, ask your doctor or nurse how to use it.

Detailed instructions for use are on the other side of this leaflet.

People with diabetes

Tell your doctor if you have diabetes. Your doctor may adjust the dose of your diabetes medicines to prevent you from getting low blood sugar.

- Do not mix wegovy up with other medicines that you inject (e.g. insulins).
- Do not use wegovy in combination with other medicines that contain GLP-1 receptor agonists (such as liraglutide, dulaglutide, exenatide or lixisenatide).

When to use wegovy

- You should use this medicine once a week and if possible, on the same day each week.
- You can give yourself the injection at any time of the day – regardless of meals.

If necessary, you can change the day of your weekly injection of this medicine as long as it has been at least 3 days since your last injection. After selecting a new dosing day, continue with once a week dosing.

If you use more wegovy than you should

Talk to your doctor straight away. You may get side effects such as feeling sick (nausea).

If you forget to use wegovy

If you forgot to inject a dose and:

- it is 5 days or less since you should have used wegovy, use it as soon as you remember. Then inject your next dose as usual on your scheduled day.
- it is more than 5 days since you should have used wegovy, skip the missed dose. Then inject your next dose as usual on your next scheduled day. Do not take a double dose to make up for a forgotten dose.

If you stop using wegovy

Do not stop using this medicine without talking to your doctor.

If you have any further questions on the use of this medicine, ask your doctor, pharmacist or nurse.

4. Possible side effects

Like all medicines, this medicine can cause side effects, although not everybody gets them.

Serious side effects

Common: may affect up to 1 in 10 people

- Complications of diabetic eye disease (diabetic retinopathy). If you have diabetes you should inform your doctor if you experience eye problems, such as changes in vision, during treatment with this medicine.

Uncommon: may affect up to 1 in 100 people

- Inflamed pancreas (acute pancreatitis). Signs of inflamed pancreas may include severe and long-lasting pain in your stomach, the pain may move to your back. You should see your doctor **immediately** if you experience such symptoms.
- Kidney or bladder stones. Signs may include back or lower abdomen pain, difficulty in urination or change in colour of your urine.

Rare: may affect up to 1 in 1,000 people

- Severe allergic reactions (anaphylactic reactions, angioedema). You should seek immediate medical help and inform your doctor straight away if you get symptoms such as breathing problems, swelling of face, lips, tongue, and/or throat with difficulty swallowing, wheezing, fast heartbeat, pale and cold skin, feeling dizzy or weak.
- Hip fractures.

Not known (frequency cannot be estimated from the available data)

- Bowel obstruction. A severe form of constipation with additional symptoms such as stomach ache, bloating, vomiting etc.

Other side effects

Very common: may affect more than 1 in 10 people

- headache
- feeling sick (nausea)
- being sick (vomiting)
- diarrhoea
- constipation
- stomach pain
- feeling weak or tired.

These usually go away over time.

Common: may affect up to 1 in 10 people

- feeling dizzy
- upset stomach or indigestion
- burping
- gas (flatulence)
- bloating of the stomach
- inflamed stomach ('gastritis') – the signs include stomach ache, feeling sick (nausea) or being sick (vomiting)
- reflux or heartburn – also called 'gastro-oesophageal reflux disease'
- gallstones
- hair loss
- injection site reactions
- change in the way food or drink tastes
- change in skin sensation
- low blood sugar (hypoglycaemia) in patients with diabetes.

The warning signs of low blood sugar may come on suddenly. They can include: cold sweat, cool pale skin, headache, fast heartbeat, feeling sick (nausea) or very hungry, changes in vision, feeling sleepy or weak, feeling nervous, anxious or confused, difficulty concentrating or shaking.

Your doctor will tell you how to treat low blood sugar and what to do if you notice these warning signs.

Low blood sugar is more likely to happen if you also take a sulfonylurea or insulin. Your doctor may reduce your dose of these medicines before you start using this medicine.

Uncommon: may affect up to 1 in 100 people

- fast heartbeat
- increase of pancreatic enzymes (such as lipase and amylase) shown in blood tests.
- a delay in the emptying of the stomach.
- low blood sugar (hypoglycaemia) in patients without diabetes.
- Increased levels of bilirubin in your blood. Signs include jaundice which is yellowing of the skin or the whites of your eyes.

Reporting of side effects

If you get any side effects, talk to your doctor, pharmacist or nurse. This includes any possible side effects not listed in this leaflet. You can also report side effects directly via the Yellow Card Scheme at: <https://yellowcard.mhra.gov.uk/> or search for MHRA Yellow Card in the Google Play or Apple App Store. By reporting side effects, you can help provide more information on the safety of this medicine.

5. How to store wegovy

Keep this medicine out of the sight and reach of children.

Do not use this medicine after the expiry date which is stated on the pen label and carton after 'EXP'. The expiry date refers to the last day of that month.

Do not freeze wegovy and do not use it if it has been frozen.

Keep the pen cap on in order to protect from light.

Before opening:

Store in a refrigerator (2°C to 8°C). Keep away from the cooling element.

During use:

You can keep the pen for 6 weeks when stored at a temperature below 30°C or in a refrigerator (2°C to 8°C) away from cooling element.

Do not use this medicine if you notice that the solution is not clear and colourless.

Do not throw away any medicines via wastewater or household waste. Ask your pharmacist how to throw away medicines you no longer use. These measures will help protect the environment.

6. Contents of the pack and other information

What wegovy contains

- The active substance is semaglutide.
- The other ingredients are disodium phosphate dihydrate, propylene glycol, phenol, sodium hydroxide/hydrochloric acid (for pH adjustment), water for injection.

wegovy 0.25 mg FlexTouch solution for injection

One mL of solution contains 0.68 mg of semaglutide. One pre-filled pen contains 1.0 mg semaglutide in 1.5 mL solution

wegovy 0.5 mg FlexTouch solution for injection

One mL of solution contains 1.34 mg of semaglutide. One pre-filled pen contains 2.0 mg semaglutide in 1.5 mL solution

wegovy 1 mg FlexTouch solution for injection

One mL of solution contains 1.34 mg of semaglutide. One pre-filled pen contains 4.0 mg semaglutide in 3 mL solution

wegovy 1.7 mg FlexTouch solution for injection

One mL of solution contains 2.27 mg of semaglutide. One pre-filled pen contains 6.8 mg semaglutide in 3 mL solution

wegovy 2.4 mg FlexTouch solution for injection

One mL of solution contains 3.2 mg of semaglutide. One pre-filled pen contains 9.6 mg of semaglutide in 3 mL solution.

What wegovy looks like and contents of the pack

wegovy is a clear and colourless solution for injection in a pre-filled disposable pen.

Each FlexTouch pen contains four doses. The pack size of each strength of wegovy contains 1 pre-filled pen and 4 disposable NovoFine Plus needles.

Your pen is designed to be used with NovoFine Plus, NovoFine or NovoTwist disposable needles up to a length of 8 mm

Marketing Authorisation Holder

Novo Nordisk A/S
Novo Allé
DK-2880 Bagsværd
Denmark

Manufacturer

Novo Nordisk A/S
Novo Allé
DK-2880 Bagsværd
Denmark

Novo Nordisk Production SAS
45, Avenue d'Orléans
28000 Chartres
France

This leaflet was last revised in 10/2024

Instructions on how to use wegovy FlexTouch

Before you begin using your once-weekly wegovy FlexTouch pen, **always read these instructions carefully**, and talk to your doctor, nurse or pharmacist about how to inject wegovy correctly. wegovy FlexTouch pen is a dial-a-dose pen that **contains four of your prescribed doses of wegovy, to be used once a week for 4 weeks.**

Please use the table inside the lid of the carton to keep track of how many injections you have taken and how many doses remain in your pen.

wegovy FlexTouch comes in five different strengths, each containing one of the following prescribed doses of semaglutide:

0.25 mg **0.5 mg** **1 mg** **1.7 mg** **2.4 mg**

Always start by checking your pen label to make sure that it contains your prescribed dose of wegovy.

Your pen is designed to be used with NovoFine Plus, NovoFine or NovoTwist disposable needles up to a length of 8 mm. **The pack contains:**

- wegovy FlexTouch pen
- 4 NovoFine Plus needles
- Leaflet

wegovy FlexTouch pen (example)

Please note: Your pen may differ in size from the pen shown in the pictures.

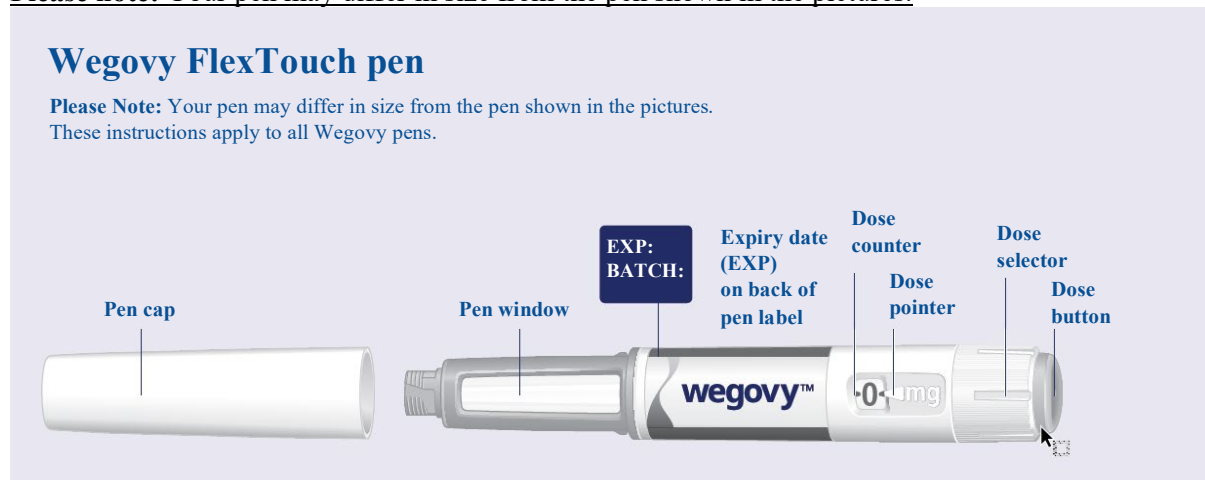

NovoFine Plus needle (example)

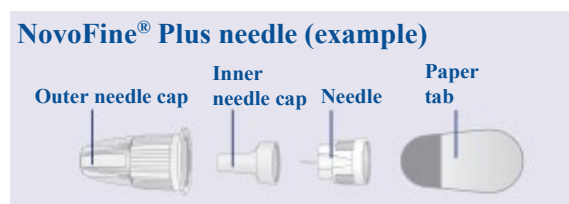

1 Prepare your pen with a new needle

Check the name and dose of your pen to make sure it contains your prescribed dose of wegovy.

Pull off the pen cap.

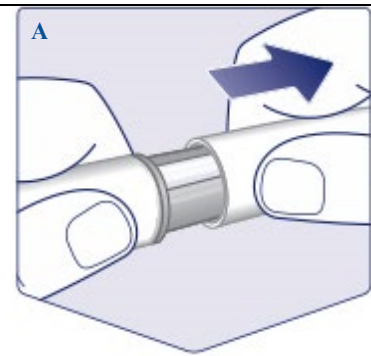

Check that the wegovy in your pen is clear and colourless. Look through the pen window. If wegovy looks cloudy or coloured, do not use the pen.

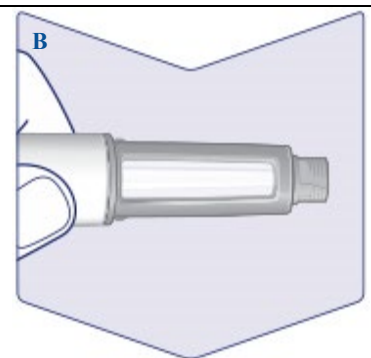

Always use a new needle for each injection.

Take a needle when you are ready to take your injection. Check the paper tab and the outer needle cap for damages. If you see any damage, this could affect sterility. Dispose of it and use a new needle.

Tear off the paper tab.

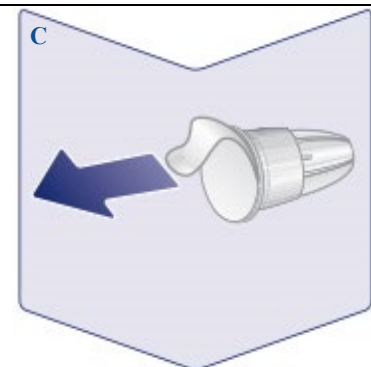

Push the needle straight onto the pen. Turn until it is on tight.

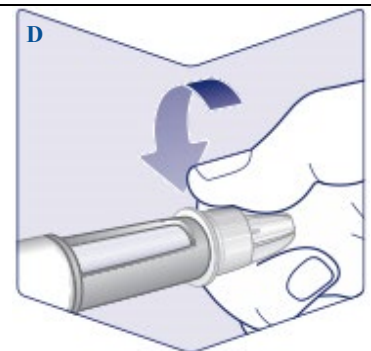

The needle is covered by two caps. You must remove both caps. If you forget to remove both caps you will not inject any Wegovy. **Pull off the outer needle cap and keep it for later.** You will need it to safely remove the needle from the pen after the injection. **Pull off the inner needle cap and dispose of it.** A drop of Wegovy may appear at the needle tip. You must still check the Wegovy flow if you use a new pen for the first time. See **‘Check the flow with each new pen’**. Never use a bent or damaged needle. For more information about needle handling, see **‘About your needles’** below these instructions.

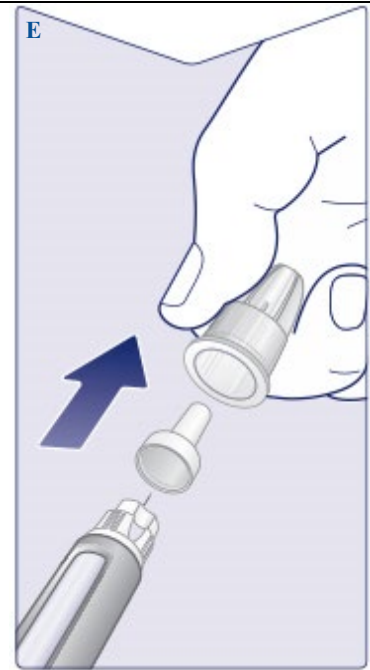

Check the flow with each new pen

Only check the Wegovy flow before your **first injection with each new pen**.

If your Wegovy pen is already in use, go to **‘2 Set your dose’**.

Turn the dose selector until you see the flow check symbol (** ←).



Make sure the flow check symbol lines up with the dose pointer.



Check the flow

Hold the pen with the needle pointing up.

Press and hold in the dose button until the dose counter returns to **0**. The **0** must line up with the dose pointer.

A drop of Wegovy should appear at the needle tip. This drop indicates that your pen is ready for use.

If a drop does not appear, check the flow again. **This should only be done twice.**

If there is still no drop, **change the needle and check the flow once more.**

Do not use the pen if a drop of Wegovy still does not appear.

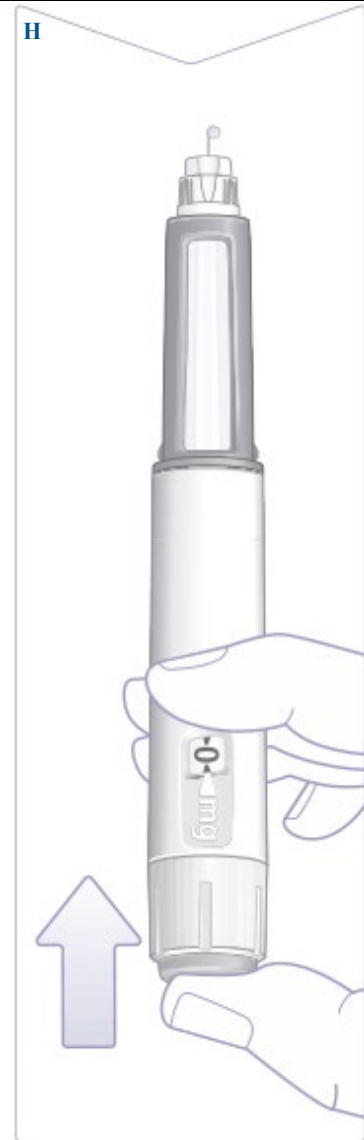

2 Set your dose

Turn the dose selector until the **dose counter stops**, and it **shows your prescribed dose**.



The dashed line () in the dose counter will guide you to your dose. The dose selector clicks differently when turned forward, backwards or past your dose. You will hear a 'click' every time you turn the dose selector. Do not set the dose by counting the number of clicks you hear.

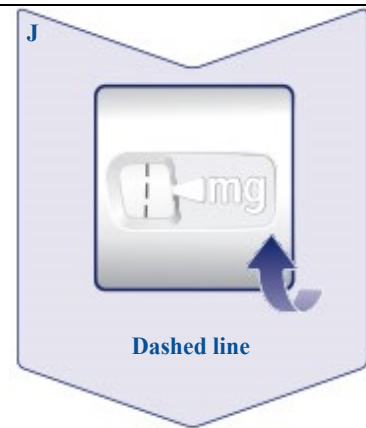

When your prescribed dose lines up with the dose pointer, you have selected your dose. In this picture, the dose **0.25 mg** is shown as an example.
If the dose counter stops before you reach your prescribed dose, see the section 'Do you have enough wegovy?' below these instructions.

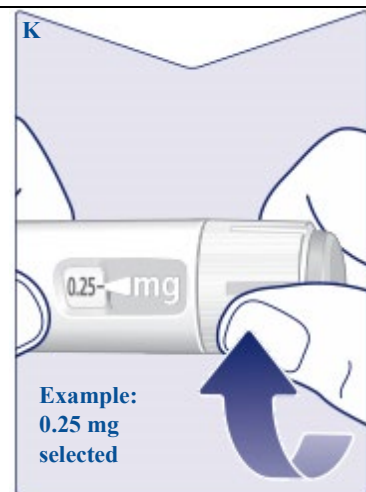

Choose your injection site

Choose upper arms, stomach or upper legs (keep a 5 cm distance from your belly button).

You may inject in the same body area each week, but make sure it is not in the same spot as used the last time.

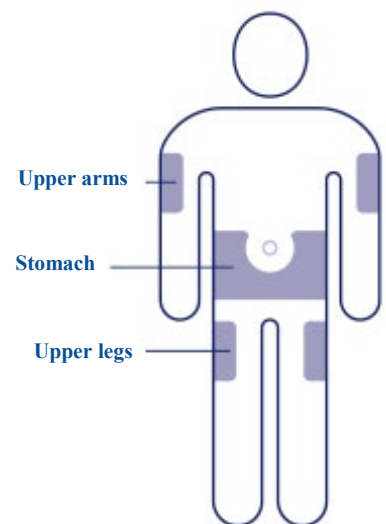

3 Inject your dose

Insert the needle into your skin.

Make sure you can see the dose counter. Do not cover it with your fingers. This could interrupt the injection.

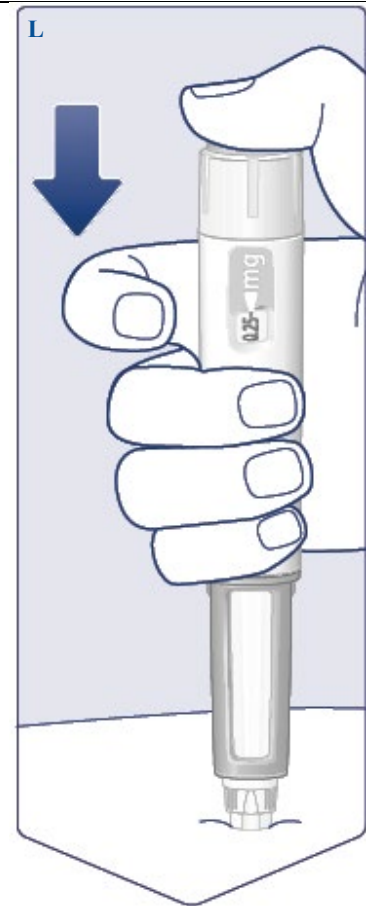

Press and hold down the dose button until the dose counter shows '0'.

Keep pressing the dose button with the needle in your skin and slowly count to 6. The '0' must line up with the dose pointer. You may hear or feel a click when the dose counter returns to '0'.

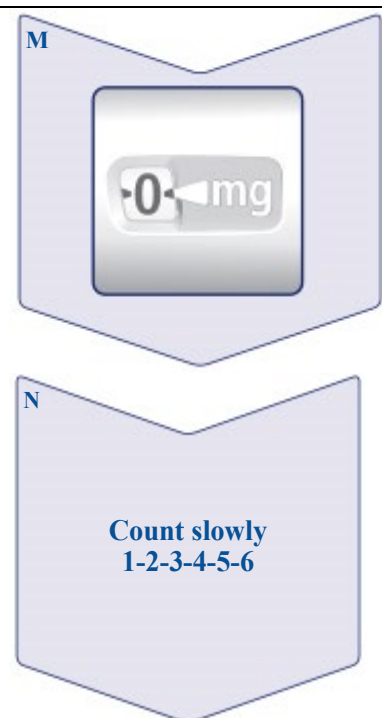

Remove the needle from your skin. If the needle is removed earlier, a stream of Wegovy may come from the needle tip and the full dose will not be delivered.
If blood appears at the injection site, press lightly on the area to stop the bleeding.
You may see a drop of Wegovy at the needle tip after injecting. This is normal and does not affect your dose.

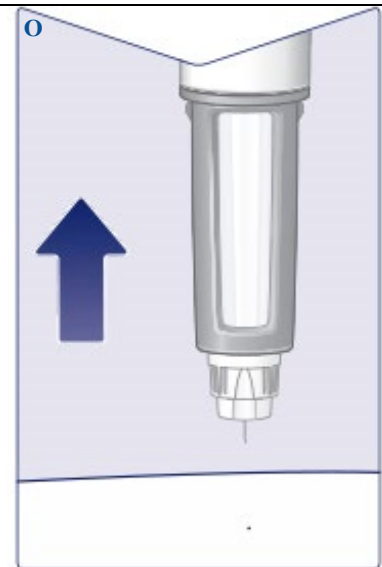

4 After your injection

Lead the needle tip into the outer needle cap on a flat surface without touching the needle or the outer needle cap.
Once the needle is covered, carefully push the outer needle cap completely on.

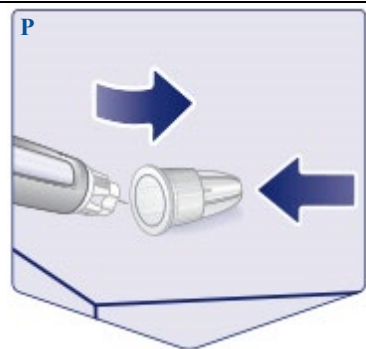

Unscrew the needle and dispose of it carefully as instructed by your doctor, nurse, pharmacist or local authorities.
Never try to put the inner needle cap back on the needle. You may stick yourself with the needle.
Always dispose of the needle immediately after each injection to prevent blocked needles, contamination, infection and inaccurate dosing. **Never store your pen with the needle attached.**

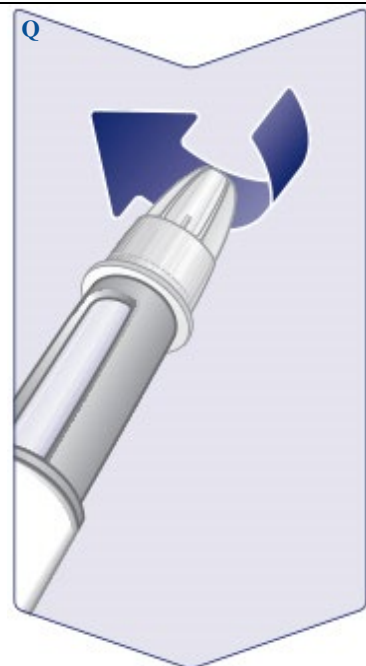

Put the pen cap on your pen after each use to protect wegovy from light.



When the pen is empty, dispose of the pen without a needle on as instructed by your doctor, nurse, pharmacist or local authorities. The pen cap and the empty carton can be disposed of in your household waste.

About your needles

Needles are medical devices.

How to identify a blocked or damaged needle

- If **0** does not appear in the dose counter after continuously pressing the dose button, you may have used a blocked or damaged needle.
- In this case, you have **not** received any wegovy – even though the dose counter has moved from the original dose that you have set.

How to handle a blocked needle

- Change the needle as instructed in ‘**1 Prepare your pen with a new needle**’ and go to ‘**2 Set your dose**’.

Caring for your pen

Treat your pen with care. Rough handling or misuse may cause inaccurate dosing. If this happens, you might not get the intended effect of wegovy.

- See the back of this leaflet to read the storage conditions for your pen.
- **Do not inject wegovy that has been exposed to direct sunlight.**
- **Do not subject wegovy to frost and never inject wegovy that has been frozen.** Dispose of the pen.
- **Do not drop your pen** or knock it against hard surfaces.
- **Do not try to refill your pen.** Once empty, it must be disposed of.
- **Do not try to repair your pen** or pull it apart.
- **Do not expose your pen to dust, dirt or liquid.**
- **Do not wash, soak or lubricate your pen.** If necessary, clean it with a mild detergent on a moistened cloth.

Do you have enough Wegovy?

If the dose counter stops before you reach your prescribed dose, there is not enough Wegovy left for a full dose. Dispose of the pen and use a new Wegovy FlexTouch pen.



Important information

- **Only inject one dose of Wegovy once weekly.** If you do not take your Wegovy as prescribed, you may not get the intended effect of this medicine.
- If you take more than one type of injectable medicine, it is very **important to check the name and dose** of your pen label **before use**.
- **Do not use this pen without help if you have poor eyesight and cannot follow these instructions.** Get help from a person with good eyesight who is trained to use the Wegovy FlexTouch pen.
- Always keep pen and needles **out of sight and reach of others, especially children**.
- **Never share** your pen or your needles with other people.
- **Needles are for single use only. Never reuse your needles** as it may lead to blocked needles, contamination, infection and inaccurate dosing.
- Caregivers must **be very careful when handling used needles** to prevent accidental needle stick injuries and infection.