

Package leaflet: Information for the patient

Skyrizi 150 mg solution for injection in pre-filled pen risankizumab

Read all of this leaflet carefully before you start using this medicine because it contains important information for you.

- Keep this leaflet. You may need to read it again.
- If you have any further questions, ask your doctor, pharmacist, or nurse.
- This medicine has been prescribed for you only. Do not pass it on to others. It may harm them, even if their signs of illness are the same as yours.
- If you get any side effects, talk to your doctor, pharmacist, or nurse. This includes any possible side effects not listed in this leaflet. See section 4.

What is in this leaflet

1. What Skyrizi is and what it is used for
2. What you need to know before you use Skyrizi
3. How to use Skyrizi
4. Possible side effects
5. How to store Skyrizi
6. Contents of the pack and other information
7. Instructions for use

1. What Skyrizi is and what it is used for

Skyrizi contains the active substance risankizumab.

Skyrizi is used to treat the following inflammatory diseases:

- Plaque psoriasis
- Psoriatic arthritis

How Skyrizi works

This medicine works by stopping a protein in the body called 'IL-23', which causes inflammation.

Plaque psoriasis

Skyrizi is used to treat adults with moderate to severe plaque psoriasis. Skyrizi reduces inflammation and can therefore help reduce symptoms of plaque psoriasis such as burning, itching, pain, redness, and scaling.

Psoriatic arthritis

Skyrizi is used to treat adults with psoriatic arthritis. Psoriatic arthritis is a disease that causes inflamed joints and psoriasis. If you have active psoriatic arthritis, you may first be given other medicines. If these medicines do not work well enough, you will be given Skyrizi either alone or in combination with other medicines to treat your psoriatic arthritis.

Skyrizi reduces inflammation and can therefore help to reduce pain, stiffness, and swelling in and around your joints, pain and stiffness in your spine, psoriatic skin rash, psoriatic nail damage, and it may slow down damage to the bone and cartilage in your joints. These effects can ease your normal daily activities, reduce tiredness, and improve your quality of life.

2. What you need to know before you use Skyrizi

Do not use Skyrizi

- if you are allergic to risankizumab or any of the other ingredients of this medicine (listed in section 6).
- if you have an infection, including active tuberculosis, which your doctor thinks is important.

Warnings and precautions

Talk to your doctor, pharmacist, or nurse before and during the use of Skyrizi:

- if you currently have an infection or if you have an infection that keeps coming back.
- if you have tuberculosis (TB).
- if you have recently received or plan to receive an immunisation (vaccine). You should not be given certain types of vaccines while using Skyrizi.

It is important to keep a record of the batch number of your Skyrizi.

Every time you get a new pack of Skyrizi, note down the date and the batch number (which is on the packaging after “Lot”) and keep this information in a safe place.

Serious allergic reactions

Skyrizi can cause serious side effects, including serious allergic reactions (‘anaphylaxis’).

Tell your doctor or seek medical help immediately if you notice any signs of an allergic reaction while you are taking Skyrizi such as:

- difficulty breathing or swallowing
- swelling of the face, lips, tongue or throat
- low blood pressure, which can cause dizziness or light-headedness
- severe itching of the skin, with a red rash or raised bumps

Children and adolescents

Skyrizi is not recommended for children and adolescents under 18 years of age. This is because Skyrizi has not been studied in this age group.

Other medicines and Skyrizi

Tell your doctor, pharmacist, or nurse:

- if you are using, have recently used or might use any other medicines.
- if you have recently had or are going to have a vaccination. You should not be given certain types of vaccines while using Skyrizi.

If you are not sure, talk to your doctor, pharmacist, or nurse before and during the use of Skyrizi.

Pregnancy, contraception and breast-feeding

If you are pregnant, think you may be pregnant or are planning to have a baby, ask your doctor for advice before using this medicine. This is because it is not known how this medicine will affect the baby.

If you are a woman who can become pregnant, you should use contraception while using this medicine and for at least 21 weeks after your last dose of Skyrizi.

If you are breast-feeding or are planning to breast-feed, talk to your doctor before using this medicine.

Driving and using machines

Skyrizi is not likely to affect your driving and use of machines.

Skyrizi contains polysorbate and sodium

This medicine contains 0.2 mg of polysorbate 20 in each 150 mg dose. Polysorbates may cause allergic reactions. Tell your doctor if you have any known allergies.

This medicine contains less than 1 mmol sodium (23 mg) per pre-filled pen, that is to say essentially 'sodium-free'.

3. How to use Skyrizi

Always use this medicine exactly as your doctor or pharmacist, has told you. Check with your doctor or pharmacist if you are not sure.

This medicine is given as an injection under your skin (called a 'subcutaneous injection').

How much Skyrizi to use

Each dose is 150 mg given as a single injection. After the first dose, you will have the next dose 4 weeks later, and then every 12 weeks.

You and your doctor, pharmacist, or nurse will decide if you should inject this medicine yourself. Do not inject yourself with this medicine unless you have been trained by your doctor, pharmacist, or nurse. A caregiver may also give your injection after they have been trained.

Read section 7 'Instructions for use' at the end of this leaflet before injecting Skyrizi yourself.

If you use more Skyrizi than you should

If you have used more Skyrizi than you should or the dose has been given sooner than prescribed, talk to your doctor.

If you forget to use Skyrizi

If you forget to use Skyrizi, inject a dose as soon as you remember. Talk to your doctor if you are not sure what to do.

If you stop using Skyrizi

Do not stop using Skyrizi without talking to your doctor first. If you stop treatment, your symptoms may come back.

If you have any further questions on the use of this medicine, ask your doctor, pharmacist, or nurse.

4. Possible side effects

Like all medicines, this medicine can cause side effects, although not everybody gets them.

Serious side effects

Allergic reactions – these may need urgent treatment. Tell your doctor or get emergency medical help straight away if you notice any of the following signs:

Serious allergic reactions ('anaphylaxis') are rare in people taking Skyrizi (may affect up to 1 in a 1 000 people). Signs include:

- difficulty breathing or swallowing
- swelling of the face, lips, tongue or throat
- low blood pressure, which can cause dizziness or light-headedness

Talk to your doctor or get medical help immediately if you have the following symptoms.

Symptoms of a serious infection such as:

- fever, flu-like symptoms, night sweats
- feeling tired or short of breath, cough which will not go away

- warm, red and painful skin, or a painful skin rash with blisters

Your doctor will decide if you can keep using Skyrizi.

Other side effects

Tell your doctor, pharmacist or nurse if you get any of the following side effects

Very common: may affect more than 1 in 10 people

- upper respiratory infections with symptoms such as sore throat and stuffy nose

Common: may affect up to 1 in 10 people

- feeling tired
- fungal skin infection
- injection site reactions (such as redness or pain)
- itching
- headache
- rash
- eczema

Uncommon: may affect up to 1 in 100 people

- small raised red bumps on the skin
- hives (urticaria)

Reporting of side effects

If you get any side effects, talk to your doctor or pharmacist. This includes any possible side effects not listed in this leaflet. You can also report side effects directly via the Yellow Card Scheme, Website: www.mhra.gov.uk/yellowcard or search for MHRA Yellow Card in the Google Play or Apple App Store.

By reporting side effects, you can help provide more information on the safety of this medicine.

5. How to store Skyrizi

Keep this medicine out of the sight and reach of children.

Do not use this medicine after the expiry date which is stated on the pen label and outer carton after 'EXP'.

Store in a refrigerator (2°C - 8°C). Do not freeze.

Keep the pre-filled pen in the original carton in order to protect from light.

If needed, you may also store the pre-filled pen out of the refrigerator (up to a maximum of 25°C) for up to 24 hours in the original carton to protect from light.

Do not use this medicine if the liquid is cloudy or contains flakes or large particles.

Do not throw away any medicines via wastewater or household waste. Ask your pharmacist how to throw away medicines you no longer use. These measures will help protect the environment.

6. Contents of the pack and other information

What Skyrizi contains

- The active substance is risankizumab. Each pre-filled pen contains 150 mg of risankizumab in 1 mL solution.
- The other ingredients are sodium acetate trihydrate, acetic acid, trehalose dihydrate, polysorbate 20 and water for injections. See section 2, "Skyrizi contains polysorbate and sodium".

What Skyrizi looks like and contents of the pack

Skyrizi is a clear and colourless to yellow liquid in a pre-filled pen. The liquid may contain tiny white or clear particles.

Each pack contains 1 pre-filled pen.

Marketing Authorisation Holder

AbbVie Ltd
Maidenhead
SL6 4UB
UK
Tel: +44 (0)1628 561090

Manufacturer

AbbVie Deutschland GmbH & Co. KG
Knollstrasse
67061 Ludwigshafen
Germany

This leaflet was last revised in 08/2025

To listen to or request a copy of this leaflet in Braille, large print or audio, please contact the Marketing Authorisation Holder.

7. Instructions for use

Please read all of section 7 before using Skyrizi

Skyrizi pre-filled pen

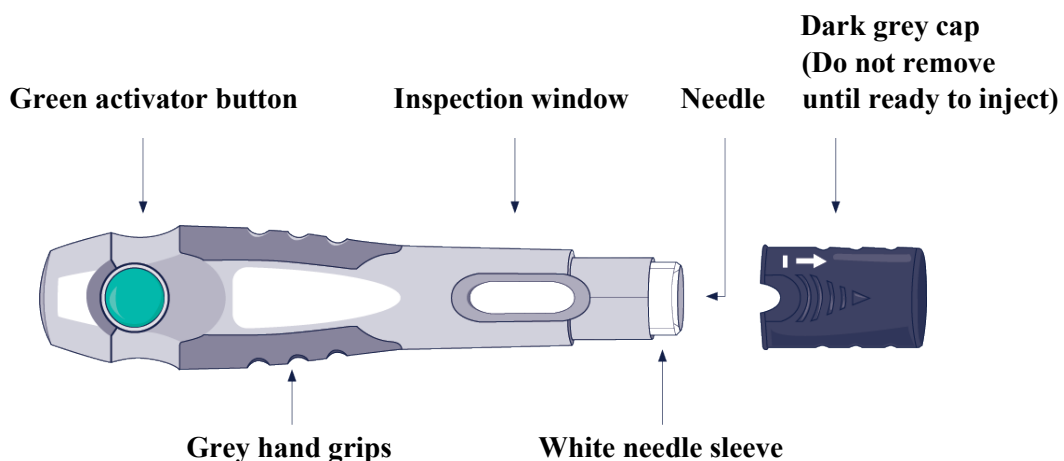



Important information to know before you inject Skyrizi

- You should receive training on how to inject Skyrizi before giving an injection. Talk to your doctor, pharmacist, or nurse if you need help
- Mark the dates on your calendar so you know when to inject Skyrizi
- Keep Skyrizi in the original carton to protect the medicine from light until it is time to use it
- Take the carton out of the refrigerator and leave it at room temperature, out of direct sunlight, for **30 to 90 minutes** before injecting
- **Do not** inject if the liquid in the inspection window is cloudy or contains flakes or large particles. The liquid should look clear to yellow and may contain tiny white or clear particles
- **Do not** shake the pen
- Wait to remove the dark grey cap until just before the injection

Return this medicine to the pharmacy

- if the expiry date (EXP) has passed
- if the liquid has ever been frozen (even if thawed)
- if the pen has been dropped or damaged
- if the carton perforations are broken

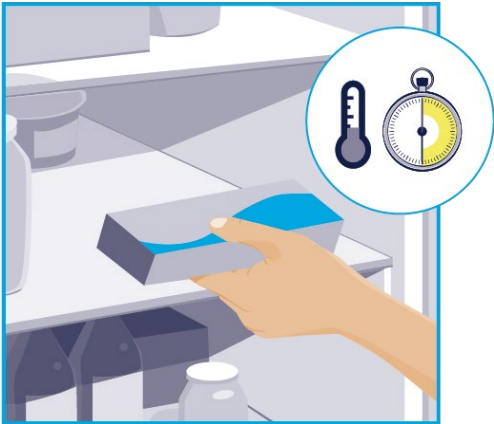
Follow the steps below each time you use Skyrizi

<p>STEP 1</p> 	<p>Take the carton out of the refrigerator and leave it at room temperature, out of direct sunlight, for 30 to 90 minutes before injecting.</p> <ul style="list-style-type: none"> • Do not remove the pen from the carton while allowing Skyrizi to reach room temperature • Do not warm Skyrizi in any other way. For example, do not warm it in a microwave or in hot water • Do not use the pen if liquid has been frozen, even if it has been thawed
<p>STEP 2</p> 	<p>Place the following items on a clean, flat surface:</p> <ul style="list-style-type: none"> • 1 pre-filled pen • 1 alcohol pad (not included in the carton) • 1 cotton ball or gauze pad (not included in the carton) • special disposal container (not included in the carton) <p>Wash and dry your hands.</p>
<p>STEP 3</p> <p>Areas to inject</p>	<p>Choose from these 3 areas to inject:</p> <ul style="list-style-type: none"> • front of left thigh • front of right thigh • your belly (abdomen) at least 5 cm from your belly button (navel)

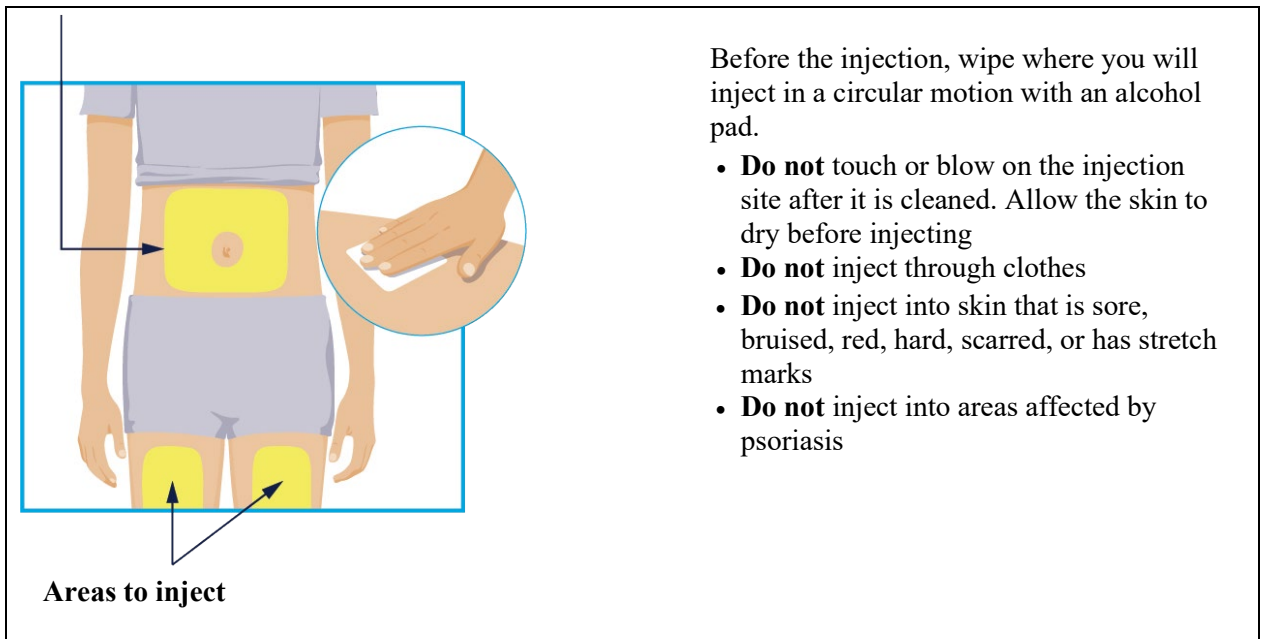

Before the injection, wipe where you will inject in a circular motion with an alcohol pad.

- **Do not** touch or blow on the injection site after it is cleaned. Allow the skin to dry before injecting
- **Do not** inject through clothes
- **Do not** inject into skin that is sore, bruised, red, hard, scarred, or has stretch marks
- **Do not** inject into areas affected by psoriasis

STEP 4

Check liquid

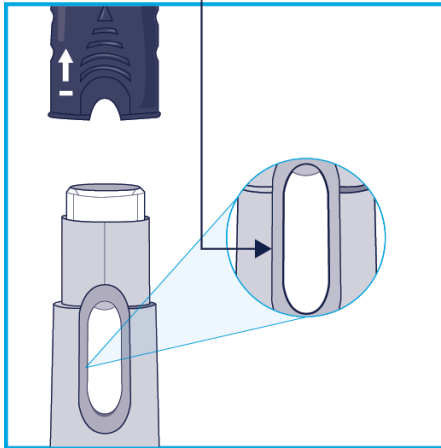

Hold the pen with the dark grey cap pointing up, as shown.

- Pull the dark grey cap straight off
- Throw the dark grey cap away

Check the liquid through the inspection window.

- It is normal to see bubbles in the liquid
- The liquid should look clear to yellow and may contain tiny white or clear particles
- **Do not** use if the liquid is cloudy or contains flakes or large particles

STEP 5

Abdomen or Thigh

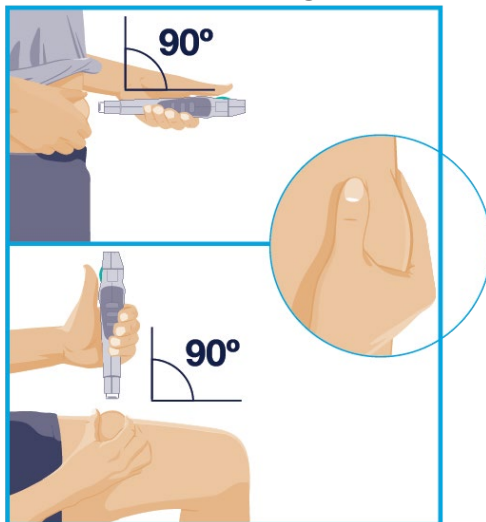

Hold the pen with your fingers on the grey hand grips.

Turn the pen so that the white needle sleeve points toward the injection site and you can see the green activator button.

Gently squeeze the skin at your injection site to make a raised area and hold it firmly.

Place the white needle sleeve straight (90° angle) against the raised injection site.

STEP 6

First “click”

15 seconds

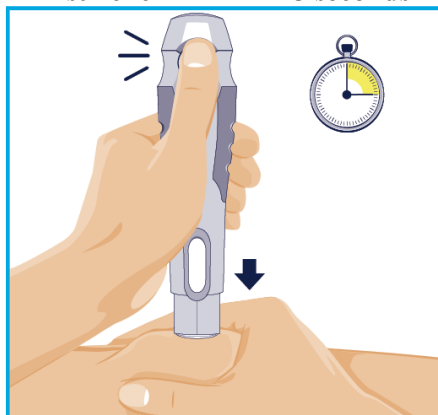

Hold the pen so that you can see the green activator button and inspection window.

Push and keep pressing the pen down against the raised injection site.

- The pen will activate only if the white needle sleeve is pressed down against the injection site before pressing the green activator button

Press the green activator button and hold the pen for **15** seconds.

- A loud “click” means the start of the injection

STEP 7

Second “click”

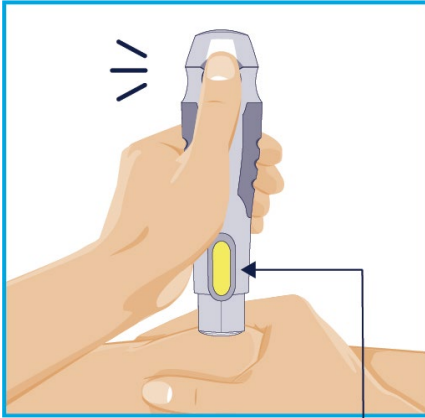

Yellow indicator

Keep pressing the pen down against the injection site.

The injection is complete when:

- the pen has made a second “click” **or**
- the yellow indicator has filled the inspection window

This takes **up to 15** seconds.

STEP 8

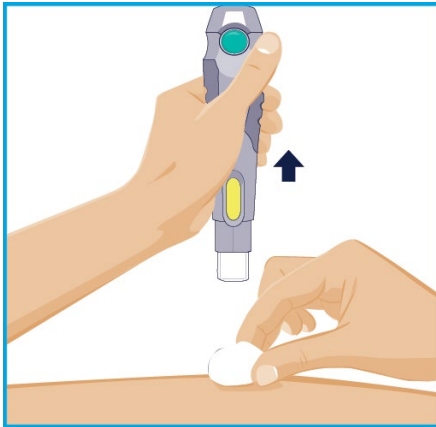

When the injection is complete, slowly pull the pen out from the skin.

The white needle sleeve will cover the needle tip and make another “click.”

After completing the injection, place a cotton ball or gauze pad on the skin at the injection site.

- **Do not** rub the injection site
- Slight bleeding at the injection site is normal

STEP 9



Throw away the used pen in a special disposal container straight after use.

- **Do not** throw away the used pen in the household waste
- Your doctor, pharmacist, or nurse will tell you how to return the full special disposal container