

Instructions For Constitution

Evrysdi 0.75 mg/mL

powder for oral solution

risdiplam

Instructions for Constitution

(FOR PHARMACISTS ONLY)

Each Evrysdi carton contains (See figure A):

- 1.** 1 Cap
- 2.** 1 Evrysdi bottle
- 3.** 2 Oral syringes 12 mL (in pouches)
- 4.** 2 Oral syringes 6 mL (in pouches)
- 5.** 1 Press-in bottle adapter
- 6.** 1 Package Leaflet (not shown)
- 7.** 1 Instructions for Constitution (not shown)
- 8.** 1 Instructions for Use (not shown)

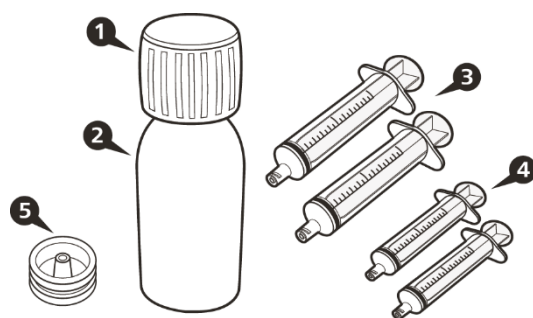

Figure A

Important information about Evrysdi

- **Avoid inhaling** Evrysdi powder.
- **Use gloves.**
- **Do not** use if the powder expiry date has passed. The powder expiration date is printed on the bottle label.
- **Do not** dispense the constituted solution if the solution's Discard After date exceeds the original powder expiration date.
- **Avoid getting contact** with the medicine on your skin. If the medicine gets on your skin, wash the area with soap and water.
- **Do not** use the medicine if any of the supplies are damaged or missing.
- Use Purified Water or Water for Injection to constitute the medicine.
- Do not add oral syringes other than the ones provided in the carton.

How to store Evrysdi

- Store the powder (unconstituted medicine) at room temperature and keep it in the carton.
- Store the solution (constituted medicine) in a refrigerator (2 to 8°C) and keep it in the carton upright.
- Keep the oral solution in the original bottle and always keep the bottle in an upright position with the cap tightly closed.

Constitution

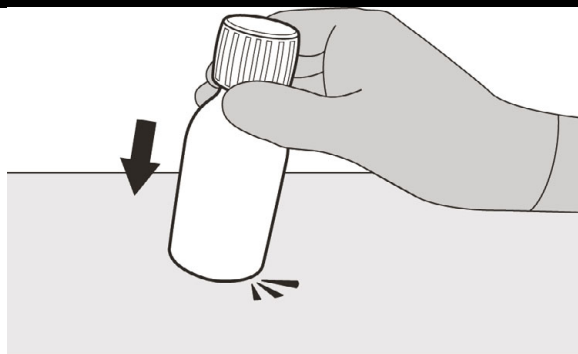

Figure B

Step 1

Gently tap the bottom of the bottle to loosen the powder (See Figure B).

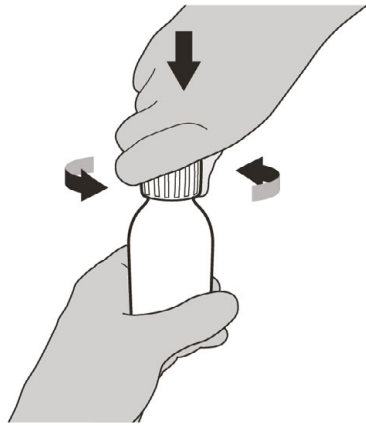

Figure C



Figure D

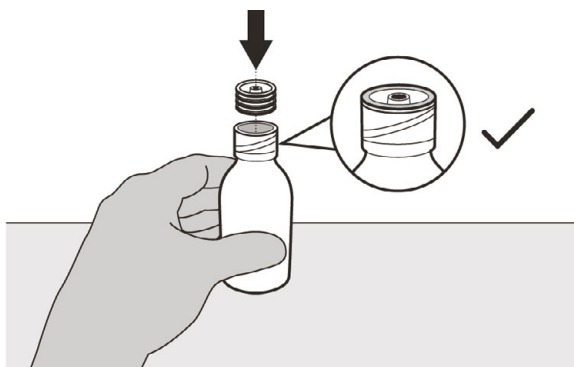

Figure E

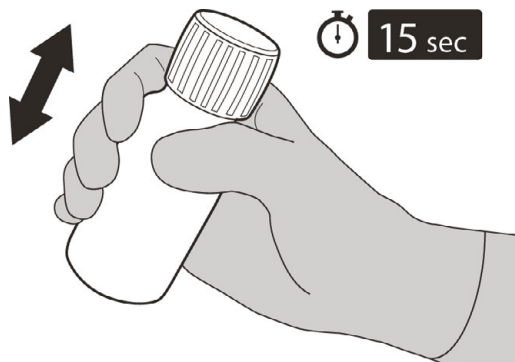

Figure F

Step 2

Remove the cap by pushing it down and then twisting to the left (counter-clockwise) (See Figure C). Do not throw away the cap.

Step 3

Carefully pour 79 mL of Purified Water or Water for Injection into the medicine bottle (See Figure D).

Step 4

Hold the medicine bottle on a table with one hand. Insert the press-in bottle adapter into the opening by pushing it down with the other hand. Ensure it is completely pressed against the bottle lip (See Figure E).

Step 5

Put the cap back on the bottle. Turn the cap to the right (clockwise) to close the bottle.

Ensure it is completely closed and then shake well for 15 seconds (See Figure F).

Wait for 10 minutes. You should have obtained a **clear solution**.

Afterwards, shake well again for another 15 seconds.



Figure G

Step 6

Calculate the Discard After date **as 64 days** after constitution (Note: the day of constitution is counted as day 0. For example, if constitution is on the 1st of April, the Discard After date will be the 4th of June).

Write the Discard After date of the solution on the bottle label (See Figure G) and carton.

Put the bottle back in its original carton, with syringes (in pouches), Package Leaflet and Instructions For Use booklet. Store the carton in the refrigerator.

Package leaflet: Information for the patient

Evrysdi 0.75 mg/mL powder for oral solution risdiplam

▼ This medicine is subject to additional monitoring. This will allow quick identification of new safety information. You can help by reporting any side effects you may get. See the end of section 4 for how to report side effects.

Read all of this leaflet carefully before you or your child start taking this medicine because it contains important information for you.

- Keep this leaflet. You may need to read it again.
- If you have any further questions, ask your doctor or pharmacist.
- This medicine has been prescribed for you or your child only. Do not pass it on to others. It may harm them, even if their signs of illness are the same as yours.
- If you or your child get any side effects, talk to your doctor or pharmacist. This includes any possible side effects not listed in this leaflet. See section 4.

What is in this leaflet

1. What Evrysdi is and what it is used for
2. What you need to know before you or your child take Evrysdi
3. How to take Evrysdi
4. Possible side effects
5. How to store Evrysdi
6. Contents of the pack and other information

1. What Evrysdi is and what it is used for

What Evrysdi is

Evrysdi is a medicine that contains the active substance risdiplam.

What is Evrysdi used for

Evrysdi is used to treat spinal muscular atrophy (SMA), a genetic disease. It can be used in patients from 2 months of age.

What spinal muscular atrophy is

SMA is caused by a shortage of a protein called survival motor neuron (SMN) protein in the body. Lack of SMN protein can cause you or your child to lose motor neurons, which are nerve cells that control muscles. This leads to muscle weakness and wasting that can affect everyday movements such as head and neck control, sitting, crawling and walking. The muscles used for breathing and swallowing may also become weaker.

How Evrysdi works

Risdiplam, the active substance in Evrysdi, works by helping the body produce more SMN protein. This means fewer motor neurons are lost, which may improve how well muscles work in people with SMA.

In infants with SMA Type 1 treated in clinical trials for 1 year, Evrysdi has helped to:

- increase how long they live and reduce the need for a ventilator to help with breathing compared to untreated infants with SMA (only 25% of untreated infants would be expected to be alive without the need for permanent ventilation beyond 14 months of age compared to 85% of patients after 1 year of treatment with Evrysdi),
- keep the ability to be fed by mouth in 83% of patients.

In children (toddlers to adolescents) and adults with SMA Type 2 and 3, Evrysdi may maintain or improve muscle control.

2. What you need to know before you or your child take Evrysdi

Do not take Evrysdi:

- if you or your child are allergic to risdiplam or any of the other ingredients of this medicine (listed in section 6).

If you are not sure, talk to your doctor or pharmacist before you or your child take Evrysdi.

Warnings and precautions

Talk to your doctor, nurse or pharmacist before you or your child take Evrysdi.

Treatment with Evrysdi may harm your unborn baby or may affect male fertility. See “**Pregnancy, contraception, breast-feeding and male fertility**” for more information.

Other medicines and Evrysdi

Tell your doctor or pharmacist if you or your child are taking, have recently taken or might take any other medicines in the future.

In particular tell your doctor, pharmacist or nurse if you are taking or have received in the past any of the following medicines:

- metformin – a medicine used to treat type II diabetes
- medicines for the treatment of SMA

Pregnancy, contraception, breast-feeding and male fertility

Pregnancy

- Do not take Evrysdi if you are pregnant. This is because taking this medicine while you are pregnant could harm your unborn baby.
- Before you start treatment with Evrysdi, your doctor should do a pregnancy test. This is because Evrysdi may harm your unborn baby.
- If you do become pregnant during your treatment with Evrysdi, tell your doctor straight away.

You and your doctor will decide what is best for you and your unborn baby.

Contraception

For women

Do not become pregnant:

- during your treatment with Evrysdi and
- for one month after you stop taking Evrysdi.

Talk to your doctor about reliable methods of birth control that you and your partner should use during treatment and for one month after you stop treatment.

For men

If your female partner is of childbearing potential, you need to avoid pregnancy. Use condoms during your treatment with Evrysdi and continue to use condoms 4 months after treatment has finished.

Breast-feeding

Do not breast-feed while taking this medicine. This is because Evrysdi may pass into breast milk and may, therefore, harm your baby.

Discuss with your doctor if you should stop breast-feeding or if you should stop taking Evrysdi.

Male fertility

Based on findings in animals, Evrysdi may reduce male fertility while on treatment and for up to 4 months after your last dose. If you are planning to have a child, ask your doctor for advice. Do not donate sperm during your treatment and for 4 months after your last dose of Evrysdi.

Driving and using machines

Evrysdi is unlikely to affect your ability to drive and use machines.

Evrysdi contains sodium

Evrysdi contains a small amount of sodium (salt) - there is less than 1 mmol (23 mg) sodium even at the highest daily dose of 5 mg (6.6 mL of 0.75 mg/mL oral solution). This means it is essentially 'sodium-free' and can be used by people on a sodium-restricted diet.

Evrysdi contains 0.375 mg of sodium benzoate per mL. Sodium benzoate may increase jaundice (yellowing of the skin and eyes) in newborn babies (up to 4 weeks old).

Evrysdi contains isomalt

Evrysdi contains 2.97 mg of isomalt per mL. If you have been told by your doctor that you or your child have an intolerance to some sugars, contact your doctor before taking this medicinal product.

3. How to take Evrysdi

Always take this medicine exactly as your doctor or pharmacist has told you. Check with your doctor or pharmacist if you are not sure. You should receive Evrysdi as a liquid in a bottle. Do not use if the medicine in the bottle is a powder, and contact your pharmacist.

You must also carefully read and follow the enclosed "**Instructions for use**" booklet on how to take or give Evrysdi.

How much Evrysdi to take

- **Adolescents and adults:** The daily dose of Evrysdi is 5 mg (6.6 mL of the oral solution).
- **Infants and children:** Your doctor will choose the right dose of Evrysdi based on your child's age and weight.

You or your child must take your daily dose as instructed by your doctor. Do not change the dose without speaking with your doctor.

When and how to take Evrysdi

- Evrysdi is a liquid which is prepared by the pharmacist, and is referred to as a ‘solution’ or ‘medicine’ in this leaflet.
- Take Evrysdi once daily after a meal at around the same time each day. This will help you remember when to take your medicine.
- Drink water after taking the medicine. Do not mix the medicine with milk or formula milk.
- Take or give Evrysdi immediately after it is drawn up into the oral syringe. If it is not taken within 5 minutes, discard the medicine from the oral syringe, and withdraw a new dose
- If Evrysdi gets on you or your child’s skin, wash the area with soap and water.

Read the ‘Instructions for use’ booklet

A booklet with ‘**Instructions for use**’ is included in the pack. It shows you how to withdraw your dose using the re-usable oral syringe given to you. You (or your child) can take the medicine:

- by mouth, or
- through a gastrostomy tube, or
- through a nasogastric tube.

How long to take Evrysdi for

Your doctor will tell you how long you or your child need to take Evrysdi for. Do not stop treatment with Evrysdi unless your doctor tells you to.

If you or your child take more Evrysdi than you should

If you or your child take more Evrysdi than you should, talk to a doctor or go to hospital straight away. Take the medicine pack and this leaflet with you.

If you or your child forget to take Evrysdi or vomits after a dose

- If it is within 6 hours of when you or your child normally take Evrysdi, take the missed dose as soon as you remember.
- If it is over 6 hours from when you or your child normally take Evrysdi, skip the missed dose and then take your next dose at the usual time. Do not take a double dose to make up for a forgotten dose.
- If you or your child vomits after taking a dose of Evrysdi, do not take an extra dose. Instead, take the next dose at the usual time the next day.

If you spill Evrysdi

If you spill Evrysdi, dry the area with a dry paper towel and then clean the area with soap and water. Throw away the paper towel in the waste and wash your hands well with soap and water.

4. Possible side effects

Like all medicines, this medicine can cause side effects, although not everybody gets them.

Very common: may affect more than 1 in 10 people

- diarrhoea
- rash
- headache
- fever

Common: may affect up to 1 in 10 people

- nausea
- mouth sores
- bladder infection
- joint pain

Reporting of side effects

If you or your child get any side effects, talk to your doctor or pharmacist or nurse. This includes any possible side effects not listed in this leaflet. You can also report side effects directly (see details below). By reporting side effects you can help provide more information on the safety of this medicine.

United Kingdom

Yellow Card Scheme

Website: www.mhra.gov.uk/yellowcard or search for MHRA Yellow Card in the Google Play or Apple App Store

5. How to store Evrysdi

- Keep this medicine out of the sight and reach of children.
- The oral solution is stable for 64 days after the pharmacist prepares it. The pharmacist will write the date of expiration on the bottle label and on the original carton after “Discard after”. Do not use the solution past this “Discard after” date.
- Store the oral solution in a refrigerator (2 to 8°C).
- Keep the medicine in the original bottle to protect from light.
- Keep the medicine bottle upright, with the cap tightly closed.
- Once you have drawn up the medicine into the oral syringe, use Evrysdi straight away. Do not store the Evrysdi solution in the syringe.

Do not throw away any medicines via wastewater or household waste. Ask your pharmacist how to throw away medicines you no longer use. These measures will help protect the environment.

6. Contents of the pack and other information

What Evrysdi contains

- The active substance in the oral solution is risdiplam.
- Each mL of the oral solution contains 0.75 mg risdiplam.
- The other ingredients are mannitol (E 421), isomalt (E 953), strawberry flavour, tartaric acid (E 334), sodium benzoate (E 211), macrogol/polyethylene glycol 6000, sucralose, ascorbic acid (E 300), disodium edetate dihydrate.

What Evrysdi looks like and contents of the pack

- Powder for oral solution, which is delivered as an oral solution after preparation by the pharmacist.
- The solution is a greenish yellow to yellow, strawberry flavoured oral solution, the volume of the solution is 80 mL.
- Each carton contains 1 bottle, 1 press-in bottle adapter, two 6-mL and two 12-mL re-usable amber oral syringes with markings to help you withdraw the right dose.

Marketing Authorisation Holder

Roche Products Limited
6 Falcon Way, Shire Park
Welwyn Garden City
AL7 1TW
United Kingdom

Manufacturer

Roche Pharma AG
Emil-Barell-Strasse 1
79639 Grenzach-Wyhlen
Germany

For any information about this medicine, please contact the local representative of the Marketing Authorisation Holder:

United Kingdom

Roche Products Ltd.
Tel: +44 (0) 1707 366000

This leaflet was last revised in September 2021

Instructions for Use – Administration

Evrysdi 0.75 mg/mL powder for oral solution

risdiplam

Be sure to read and understand the **Instructions for Use** before you start using Evrysdi. These instructions show you how to prepare and give Evrysdi through an oral syringe, gastrostomy tube (G-tube), or nasogastric tube (NG-tube).

If you have any questions about how to use Evrysdi, speak with your doctor or pharmacist.

Evrysdi should come as a liquid in a bottle when you receive it. Evrysdi is prepared by a pharmacist into an oral solution. **Do not** use if the medicine in the bottle is a powder and contact your pharmacist.

Important information about Evrysdi

- Ask your doctor or pharmacist to show you which oral syringe you should use and how to measure your daily dose.
- Always use the re-usable oral syringes in the pack to measure your daily dose.
- Two oral syringes of each size are provided in case one gets lost or damaged. Contact your doctor or pharmacist if both oral syringes are lost or damaged. They will advise you about how to continue to take your medicine.
- See “**How to select the correct oral syringe for your dose of Evrysdi**”. Ask your pharmacist if you have questions on how to select the right oral syringe.
- If the bottle adapter is not in the bottle, **do not** use Evrysdi and contact your pharmacist.
- **Do not** use Evrysdi after the **Discard after** date written on the bottle label. Ask your pharmacist for the **Discard after** date if it is not written on the bottle label.
- **Do not** mix Evrysdi with milk or formula milk.
- **Do not** use Evrysdi if the bottle or oral syringes are damaged.
- **Avoid** getting Evrysdi on your skin. If Evrysdi gets on your skin, wash the area with soap and water.
- If you spill Evrysdi, dry the area with a dry paper towel and then clean the area with soap and water. Throw away the paper towel in the waste and wash your hands well with soap and water.
- If there is not enough Evrysdi left in the bottle for your dose, discard the bottle with remaining Evrysdi and used oral syringes according to your local requirements; use a new bottle of Evrysdi for your full dose. **Do not mix** Evrysdi from the new bottle with the bottle you are currently using.

Each EVRYSDI carton contains (See figure A):

1. 1 Evrysdi bottle with bottle adapter and cap
2. 2 Oral syringes 6 mL (in pouches)
3. 2 Oral syringes 12 mL (in pouches)
4. 1 Instructions for Use booklet (not shown)
5. 1 Package Leaflet (not shown)

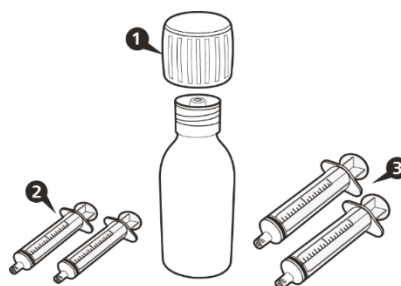

Figure A

How to store Evrysdi

Please see section 5 “*How to store Evrysdi*” of the Package Leaflet for full information.

A) Withdrawing your dose volume

How to select the correct oral syringe for your dose of Evrysdi

- If your daily dose of Evrysdi is between 1 mL and 6 mL, use a 6-mL oral syringe (grey label). Ask your doctor or pharmacist about rounding your or your child's daily dose to the nearest 0.1 mL.
- If your daily dose of Evrysdi is more than 6 mL, use a 12-mL oral syringe (brown label). Ask your doctor or pharmacist about rounding your or your child's daily dose to the nearest 0.2 mL.

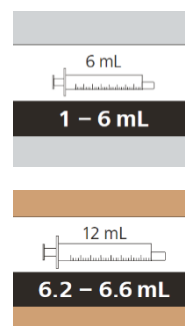

How to withdraw your dose of Evrysdi

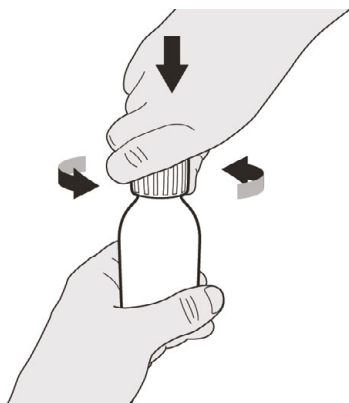

Figure B

Step A1

Remove the cap by pushing it down and then twisting it to the left (counter-clockwise) (See Figure B). Do not throw away the cap.

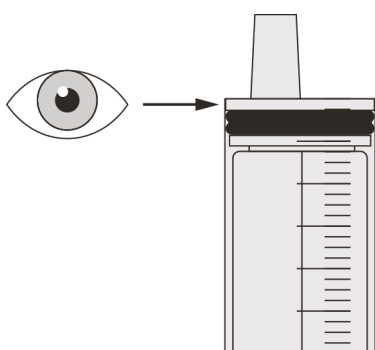

Figure C

Step A2

Push the plunger of the oral syringe all the way down to remove any air in the oral syringe (See Figure C).

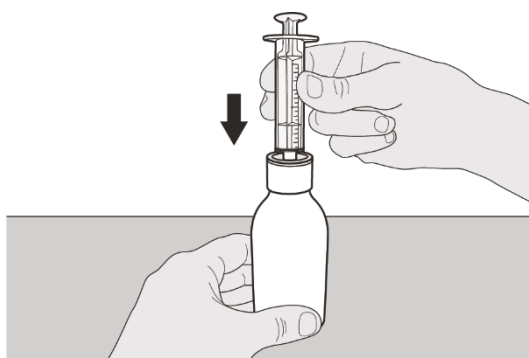

Figure D

Step A3

Keeping the bottle upright, insert the syringe tip into the bottle adapter (See Figure D).

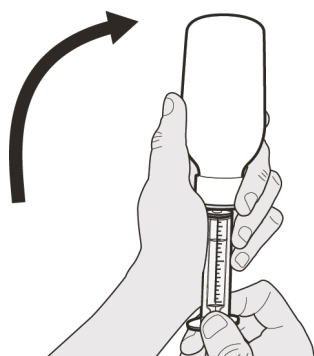

Figure E

Step A4

Carefully turn the bottle upside down with the syringe tip firmly inserted into the bottle adapter (See Figure E).

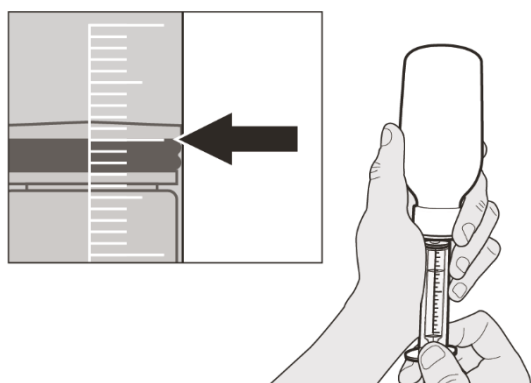

Figure F

Step A5

Slowly pull back on the plunger to withdraw your dose of Evrysdi. The top of the black plunger stopper must line up with the mL marking on the oral syringe for your daily dose (See Figure F).

After you have drawn up the correct dose, **hold the plunger in place to keep it from moving.**

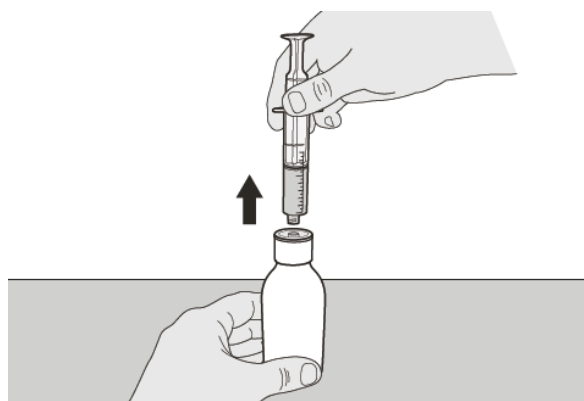

Figure G

Step A6

Continue to hold the plunger in place to stop it moving. Leave the oral syringe in the bottle adapter and turn the bottle to an upright position. Place the bottle onto a flat surface. Remove the oral syringe from the bottle adapter by gently pulling straight up on the oral syringe (See Figure G).

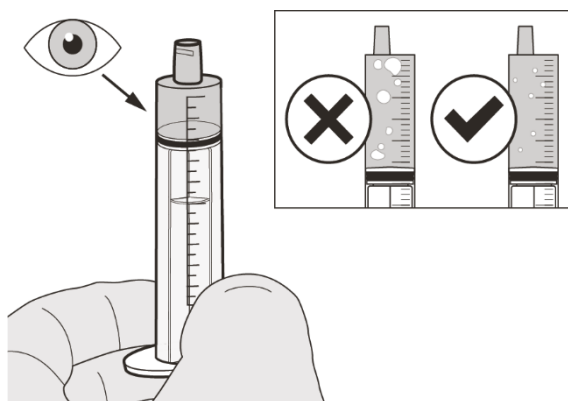

Figure H

Step A7

Hold the oral syringe with the syringe tip pointing up. Check the medicine in the oral syringe. **If** there are large air bubbles in the oral syringe (See Figure H) **or if** you have drawn up the wrong dose of Evrysdi, insert the syringe tip firmly into the bottle adapter. Push the plunger all the way down so that the medicine flows back into the bottle and repeat Steps A4 to A7.

Take or give Evrysdi immediately after it is drawn up into the oral syringe.

If it is not taken **within 5 minutes**, discard the medicine from oral syringe and withdraw a new dose.

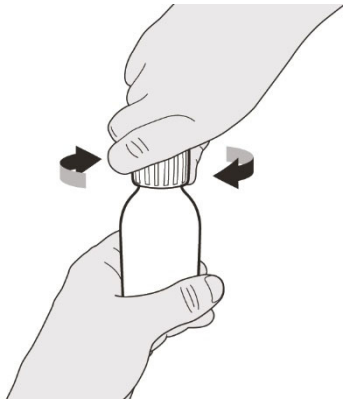

Figure I

Step A8

Put the cap back on the bottle. Turn the cap to the right (clockwise) to tightly close the bottle (See Figure I). Do not remove the bottle adapter from the bottle.

If you are taking your dose of Evrysdi by mouth, follow the instructions in **“B) How to take a dose of Evrysdi by mouth”**.

If you are taking your dose of Evrysdi through a gastrostomy tube, follow the instructions in **“C) How to give a dose of Evrysdi through a gastrostomy tube”**.

If you are taking your dose of Evrysdi through a nasogastric tube, follow the instructions in **“D) How to give a dose of Evrysdi through a nasogastric tube”**.

B) How to take a dose of Evrysdi by mouth

Sit upright when taking a dose volume of Evrysdi by mouth.



Figure J

Step B1

Place the oral syringe into the mouth **with the tip along either cheek**.

Slowly push the plunger all the way down to give the full dose of Evrysdi (See Figure J).

Giving Evrysdi into the back of the throat or too fast may cause choking.

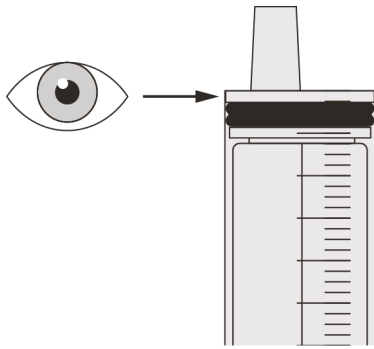

Figure K

Step B2

Check that there is no medicine left in the oral syringe (See Figure K).



Figure L

Step B3

Drink some water right after taking the dose of Evrysdi (See Figure L).

Go to Step E for cleaning of the syringe.

C) How to give a dose of Evrysdi through a gastrostomy tube

If you are giving Evrysdi through a gastrostomy tube, ask your doctor or nurse to show you how to inspect the gastrostomy tube before giving Evrysdi.

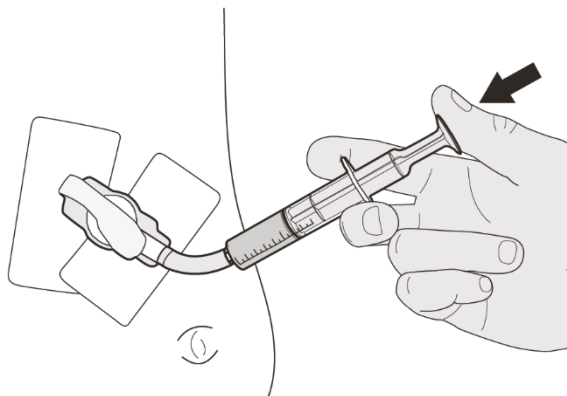

Figure M

Step C1

Place the oral syringe tip into the gastrostomy tube. Slowly push the plunger all the way down to give the full dose of Evrysdi (See Figure M).

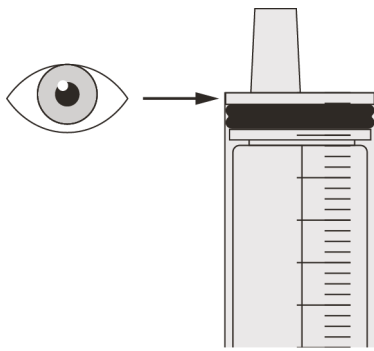

Figure N

Step C2

Check that there is no medicine left in the oral syringe (See Figure N).

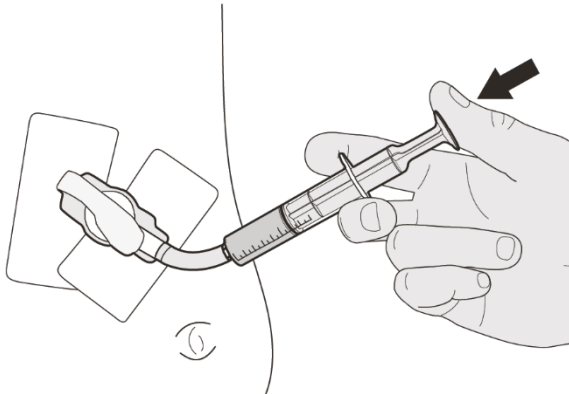

Figure O

Step C3

Flush the gastrostomy tube with 10-20 mL of water right after giving the dose of Evrysdi (See Figure O).

Go to Step E for cleaning of the syringe.

D) How to give a dose of Evrysdi through a nasogastric tube

If you are giving Evrysdi through a nasogastric tube, ask your doctor or nurse to show you how to inspect the nasogastric tube before giving Evrysdi.

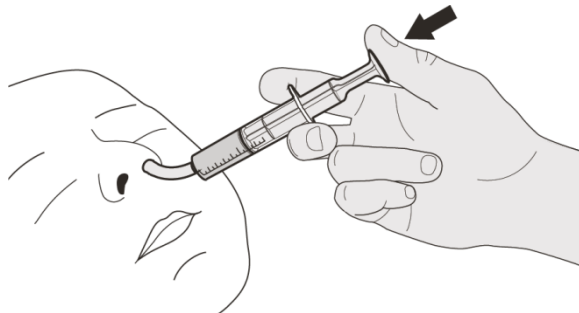

Figure P

Step D1

Place the oral syringe tip into the nasogastric tube. Slowly press the plunger all the way down to give the full dose of Evrysdi (See Figure P).

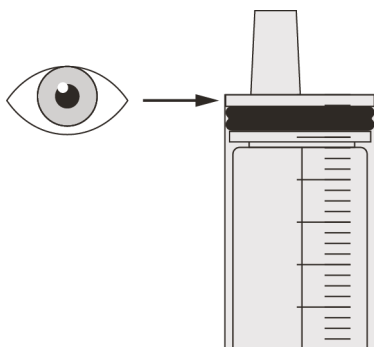

Figure Q

Step D2

Check that there is no medicine left in the oral syringe (See Figure Q).

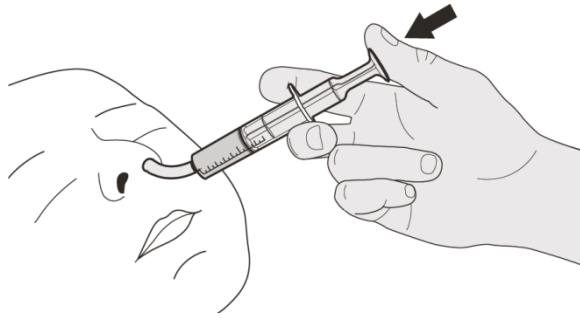

Figure R

Step D3

Flush the nasogastric tube with 10-20 mL of water right after giving the dose of Evrysdi (See Figure R).

Go to Step E for cleaning of the syringe.

E) How to clean the oral syringe after use

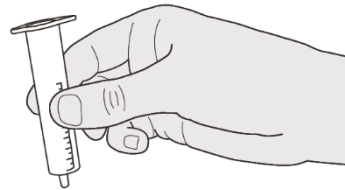
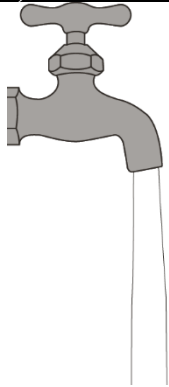

Figure S

Step E1

Remove the plunger from the oral syringe.

Rinse the oral syringe barrel well under clean water (See Figure S).

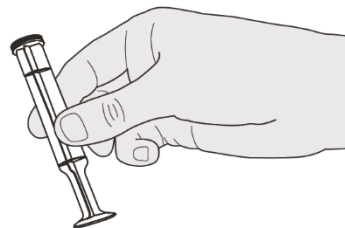
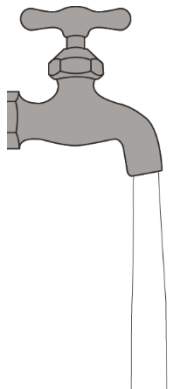

Figure T

Step E2

Rinse the plunger well under clean water (See Figure T).

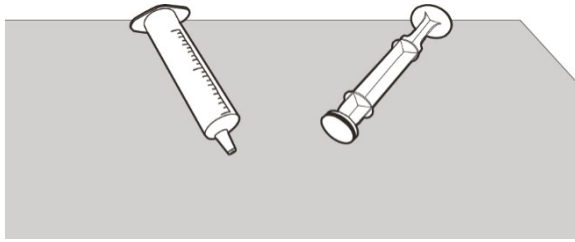

Figure U

Step E3

Check that the oral syringe barrel and plunger are clean.

Place the oral syringe barrel and plunger on a clean surface in a safe place to dry (See Figure U).

Wash your hands.

Once dry, reassemble the plunger into the oral syringe barrel and store the syringe with your medicine.