

Bayer plc

400 South Oak Way, Reading, RG2 6AD

Telephone: +44 (0) 118 206 3000

Medical information: medical.information@bayer.co.uk.www: <http://www.bayer.co.uk>

Due to regulatory changes, the content of the following Patient Information Leaflet may vary from the one found in your medicine pack. Please compare the 'Leaflet prepared/revised date' towards the end of the leaflet to establish if there have been any changes.

If you have any doubts or queries about your medication, please contact your doctor or pharmacist.

Package leaflet: Information for the user**Xarelto 1 mg/mL granules for oral suspension**

rivaroxaban

▼ This medicine is subject to additional monitoring. This will allow quick identification of new safety information. You can help by reporting any side effects you may get. See the end of section 4 for how to report side effects.

Read all of this leaflet carefully before you start taking this medicine because it contains important information. This leaflet has been written for the patient (“you”) and the parent or caregiver who will give this medicine to the child.

- Keep this leaflet. You may need to read it again.
- If you have any further questions, ask your doctor or pharmacist.
- This medicine has been prescribed for you or the child only. Do not pass it on to others. It may harm them, even if their signs of illness are the same.
- If you or the child get any side effects, talk to your doctor or pharmacist. This includes any possible side effects not listed in this leaflet. See section 4.

What is in this leaflet

1. What Xarelto is and what it is used for
2. What you need to know before you take or give Xarelto
3. How to take or give Xarelto
4. Possible side effects
5. How to store Xarelto
6. Contents of the pack and other information

1. What Xarelto is and what it is used for

Xarelto contains the active substance rivaroxaban.

Xarelto belongs to a group of medicines called antithrombotic agents. It works by blocking a blood clotting factor (factor Xa) and thus reducing the tendency of the blood to form clots.

Xarelto is used in full-term newborn babies, infants and toddlers, children and adolescents below 18 years to:

- treat blood clots and prevent re-occurrence of blood clots in the veins or in the blood vessels of the lungs, following an initial treatment of at least 5 days with injectable medicines used to treat blood clots.

Read and follow the Instructions for Use provided with this medicine because it will show you how to prepare and take or give Xarelto oral suspension.

2. What you need to know before you take or give Xarelto

Do not take or give Xarelto if you or the child

- **are allergic** to rivaroxaban or any of the other ingredients of this medicine (listed in section 6)
- **are bleeding excessively**
- **have a disease or condition in an organ of the body that increases the risk of serious bleeding (e.g. stomach ulcer, injury or bleeding in the brain, recent surgery of the brain or eyes)**
- are taking medicines to prevent blood clotting (e.g. warfarin, dabigatran, apixaban or heparin), except
 - when changing medicines to prevent blood clotting or
 - while getting heparin through a venous or arterial line to keep it open.
- **have a liver disease** associated with an increased risk of bleeding
- **are pregnant or breast-feeding**

Do not take or give Xarelto and tell your doctor if any of these apply to you or the child.

Warnings and precautions

Talk to your doctor or pharmacist before using Xarelto if:

- you or the child have **an increased risk of bleeding. This could be the case in situations** such as:
 - moderate or severe kidney disease; as the kidney function may affect the amount of medicine that works in the body
 - if you or the child are taking other medicines to prevent blood clotting (e.g. warfarin, dabigatran, apixaban or heparin), if these are absolutely necessary (see section “Do not take or give Xarelto”)
 - **bleeding disorders**
 - **very high blood pressure**, not controlled by medical treatment
 - diseases of stomach or bowel that might result in bleeding, e.g. inflammation of the bowels or stomach, or inflammation of the food pipe due to a disease where stomach acid goes upwards into the food pipe
 - **a problem with the blood vessels in the back of the eyes** (retinopathy)
 - a lung disease where the bronchi are widened and filled with pus (bronchiectasis), or previous bleeding from the lung
- you or the child have a prosthetic heart valve
- you or the child have a disease called antiphospholipid syndrome (a disorder of the immune system that causes an increased risk of blood clots)
- your or the child’s blood pressure is unstable
- another treatment or surgical procedure is planned to remove the blood clot from the lungs

If any of the above apply to you or to the child, tell your doctor before you take or give Xarelto.

The doctor will decide, if you or the child should be treated with this medicine and should be kept under closer observation.

Do not give Xarelto to children under 6 months of age who

- were born before 37 weeks of pregnancy, or
- weigh less than 2.6 kg, or

- had less than 10 days of breast or formula feeding

In these cases, dosing of Xarelto cannot be reliably determined and has not been studied in these children.

If you or the child need to have an operation

- It is very important to take or give Xarelto before and after the operation exactly at the times your doctor has told you.
- If the operation involves a catheter or injection into the spinal column (e.g. for epidural or spinal anaesthesia or pain reduction):
 - **it is very important to take or give Xarelto before and after the injection or removal of the catheter exactly at the times your doctor has told you**
 - tell your doctor immediately if you or the child get numbness or weakness of the legs or problems with the bowel or bladder after the end of anaesthesia. In this case, urgent care is necessary.

Children and adolescents

Xarelto oral suspension is to be used for patients below 18 years to treat blood clots and prevent re-occurrence of blood clots in the veins or in the blood vessels of the lungs. There is not enough information on its use in children and adolescents in other indications.

Other medicines and Xarelto

Tell your doctor or pharmacist if you or the child are taking, have recently taken or might take any other medicines, including medicines obtained without a prescription.

- If you or the child are taking:
 - some medicines for fungal infections (e.g. fluconazole, itraconazole, voriconazole, posaconazole), unless they are only applied to the skin
 - ketoconazole tablets (used to treat Cushing's syndrome - when the body produces an excess of cortisol)
 - some medicines for bacterial infections (e.g. clarithromycin, erythromycin)
 - some medicines for HIV/AIDS (e.g. ritonavir)
 - other medicines to reduce blood clotting (e.g. enoxaparin, clopidogrel or vitamin K antagonists such as warfarin and acenocoumarol)
 - medicines to relieve inflammation and pain (e.g. naproxen or acetylsalicylic acid)
 - dronedarone, a medicine to treat abnormal heart beat
 - some medicines to treat depression (selective serotonin reuptake inhibitors (SSRIs) or serotonin norepinephrine reuptake inhibitors (SNRIs))

If any of the above apply to you or the child, tell your doctor before taking or giving Xarelto, because the effect of Xarelto may be increased. Your doctor will decide, if you or the child should be treated with this medicine and should be kept under closer observation.

If the doctor thinks that you or the child are at increased risk of developing stomach or bowel ulcers, a preventive ulcer treatment might be necessary.

- If you or the child are taking:
 - some medicines to treat epilepsy (phenytoin, carbamazepine, phenobarbital)
 - St John's Wort (*Hypericum perforatum*), a herbal product used for depression
 - rifampicin, an antibiotic

If any of the above apply to you or the child, tell your doctor before taking or giving Xarelto, because the effect of Xarelto may be reduced. The doctor will decide, if you or the child should be treated with Xarelto and should be kept under closer observation.

Pregnancy and breast-feeding

- If you or the adolescent are pregnant or breast-feeding **do not take or give Xarelto.**

- If there is a **chance** that you or the adolescent could **become pregnant**, a reliable **contraceptive** should be used while taking Xarelto.
- If you or the adolescent become pregnant while taking this medicine, tell your doctor immediately, who will decide how the treatment should be continued.

Driving and using machines

Xarelto may cause dizziness or fainting. You or the child should not drive, ride a bicycle or use any tools or machines if affected by these symptoms.

Xarelto contains sodium benzoate and sodium

This medicine contains 1.8 mg sodium benzoate (E 211) in each mL oral suspension. Sodium benzoate (E 211) may increase jaundice (yellowing of the skin and eyes) in newborn babies (up to 4 weeks old).

This medicine contains less than 1 mmol sodium (23 mg) per millilitre, that is to say essentially “sodium-free”.

3. How to take or give Xarelto

Always take this medicine or give this medicine to the child exactly as your doctor has told you. Check with your doctor or pharmacist if you are not sure.

Make sure that the correct information on how much and how often to take or give Xarelto is written on the designated area of the carton. If not, ask your pharmacist or doctor to provide the relevant information.

Instructions for Use

For how to prepare and take or give the Xarelto oral suspension:

- See the Instructions for Use booklet included in the carton and
- Watch the educational video which you can access via the QR code which is displayed on the Patient Alert Card that is provided with this medicine.

How to take or give

Take or give Xarelto oral suspension with feeding (breast milk or formula feeding) or with a meal. Each Xarelto dose has to be swallowed along with one typical serving of liquid (for example 20 mL in children aged 6 months up to 240 mL in adolescents). This typical serving may include usual amount of drink used for feeding (e.g. breast milk, infant formula, nutrition drink).

Your doctor may give the oral suspension also via a stomach tube.

How much to take or give

The dose of Xarelto depends on the patient’s body weight. It will be calculated by the doctor as an amount (volume) in millilitres (mL) of the oral suspension. This should be measured out using the blue syringe (either 1 mL or 5 mL or 10 mL syringe, see table 1) supplied with this medicine. Your doctor will prescribe the volume required including the particular syringe you should use.

Your doctor will tell you how much of the oral suspension you or the child must take.

Below is the table that your doctor will use. **Do not adjust the dose yourself.**

All materials to prepare and administer the oral suspension are provided with the medicine (except for drinking water.) Only use non-carbonated water to avoid bubbles. **Only use the syringe provided** to administer Xarelto to ensure accurate dosing. Do not use any other method to administer the solution, e.g. alternative syringe, spoon etc.

As the Xarelto dose is based on body weight it is important to keep scheduled doctor's visits because the dose may need to be adjusted as the weight changes, especially for children below 12 kg. This ensures that the child receives the correct dose of Xarelto.

Table 1: Recommended dose for Xarelto in children

Body weight [kg]	Single dose*	Daily frequency of intake	Total daily dose*	Suitable blue syringe
2.6 to under 3	0.8 mL	3 times	2.4 mL	1 mL
3 to under 4	0.9 mL		2.7 mL	
4 to under 5	1.4 mL		4.2 mL	5 mL
5 to under 7	1.6 mL		4.8 mL	
7 to under 8	1.8 mL		5.4 mL	
8 to under 9	2.4 mL		7.2 mL	
9 to under 10	2.8 mL		8.4 mL	
10 to under 12	3.0 mL		9.0 mL	
12 to under 30	5.0 mL	2 times	10.0 mL	5 mL or 10 mL
30 to under 50	15.0 mL	once	15.0 mL	10 mL
50 or more	20.0 mL		20.0 mL	

* 1 mL of the oral suspension corresponds to 1 mg rivaroxaban.

Your doctor may also prescribe tablets if you or the child are able to swallow the tablet and are weighing at least 30 kg.

When to take or give Xarelto

Take or give the oral suspension as directed every day until the doctor tells you to stop. Take or give the oral suspension at the same time every day to help you to remember it. Consider setting an alarm to remind you. Please observe the child to ensure the full dose is taken.

- If the doctor has told you to take or give Xarelto:
- once a day, do this approximately 24 hours apart
 - twice a day, do this approximately 12 hours apart
 - three times a day, do this approximately 8 hours apart

Your doctor will decide how long you or the child must continue treatment.

If you or the child spits up the dose or vomits

- less than 30 minutes after the intake of Xarelto, take or give a new dose.
- more than 30 minutes after the intake of Xarelto, **do not** take or give a new dose. Continue to take or give the next Xarelto dose at the next scheduled time.

Contact the doctor if you or the child repeatedly spit up the dose or vomit after taking Xarelto.

If you forget to take or give Xarelto

- **If you are taking or giving Xarelto once a day**, take or give the missed Xarelto dose as soon as you remember on the same day. If this is not possible, skip this dose. Then take or give the next Xarelto dose on the following day. Do not take or give more than one dose per day.
- **If you are taking or giving Xarelto twice a day:**
 - Missed morning dose: Take or give the missed dose as soon as you remember. You may take or give it together with the evening dose.
 - Missed evening dose: You may take or give the missed dose only in the same evening. Do not take or give two doses the next morning.
- **If you are taking or giving Xarelto three times a day**, do not make up for the missed dose. Continue with the next scheduled dose (given every 8 hours).

On the day following a missed dose, continue as prescribed by the doctor once, twice or three times a day.

If you take or give more Xarelto than you should

Contact your doctor immediately if you have taken or given too much Xarelto oral suspension. Taking or giving too much Xarelto increases the risk of bleeding.

If you stop taking or giving Xarelto

Do not stop Xarelto without talking to your doctor first, because Xarelto treats and prevents serious conditions.

If you have any further questions on the use of this medicine, ask your doctor or pharmacist.

4. Possible side effects

Like all medicines, this medicine can cause side effects, although not everybody gets them.

Like other similar medicines to reduce the formation of blood clots, Xarelto may cause bleeding which may potentially be life threatening. Excessive bleeding may lead to a sudden drop in blood pressure (shock). In some cases the bleeding may not be obvious.

Tell your doctor immediately if you or the child experience any of the following side effects:

- **Signs of bleeding**
 - bleeding into the brain or inside the skull (symptoms can include headache, one-sided weakness, vomiting, seizures, decreased level of consciousness, and neck stiffness. A serious medical emergency. Seek medical attention immediately!)
 - long or excessive bleeding
 - exceptional weakness, tiredness, paleness, dizziness, headache, unexplained swelling, breathlessness, chest pain or angina pectoris

Your doctor may decide to keep you or the child under closer observation or change the treatment.

- **Signs of severe skin reactions**
 - spreading intense skin rash, blisters or mucosal lesions, e.g. in the mouth or eyes (Stevens-Johnson syndrome/toxic epidermal necrolysis)
 - a drug reaction that causes rash, fever, inflammation of internal organs, blood abnormalities and systemic illness (DRESS syndrome)

The frequency of these side effects is very rare (up to 1 in 10,000 people).

- **Signs of severe allergic reactions**
 - swelling of the face, lips, mouth, tongue or throat; difficulty swallowing; hives and breathing difficulties; sudden drop in blood pressure

The frequencies of severe allergic reactions are very rare (anaphylactic reactions, including anaphylactic shock; may affect up to 1 in 10,000 people) and uncommon (angioedema and allergic oedema; may affect up to 1 in 100 people).

Overall list of possible side effects found in adults and children and adolescents:

Common (may affect up to 1 in 10 people)

- reduction in red blood cells which can make the skin pale and cause weakness or breathlessness
- bleeding in the stomach or bowel, urogenital bleeding (including blood in the urine and heavy menstrual bleeding), nose bleed, bleeding in the gum

- bleeding into the eye (including bleeding from the whites of the eyes)
- bleeding into tissue or a cavity of the body (haematoma, bruising)
- coughing up blood
- bleeding from the skin or under the skin
- bleeding following an operation
- oozing of blood or fluid from surgical wound
- swelling in the limbs
- pain in the limbs
- impaired function of the kidneys (may be seen in tests performed by your doctor)
- fever
- stomach ache, indigestion, feeling or being sick, constipation, diarrhoea
- low blood pressure (symptoms may be feeling dizzy or fainting when standing up)
- decreased general strength and energy (weakness, tiredness), headache, dizziness
- rash, itchy skin
- blood tests may show an increase in some liver enzymes

Uncommon (may affect up to 1 in 100 people)

- bleeding into the brain or inside the skull (see above, possible side effects which may be a sign of bleeding)
- bleeding into a joint causing pain and swelling
- thrombocytopenia (low number of platelets, which are cells that help blood to clot)
- allergic reactions, including allergic skin reactions
- impaired function of the liver (may be seen in tests performed by your doctor)
- blood tests may show an increase in bilirubin, some pancreatic or liver enzymes or in the number of platelets
- fainting
- feeling unwell
- faster heartbeat
- dry mouth
- hives

Rare (may affect up to 1 in 1,000 people)

- bleeding into a muscle
- cholestasis (decreased bile flow), hepatitis incl. hepatocellular injury (inflamed liver incl. liver injury)
- yellowing of the skin and eye (jaundice)
- localised swelling
- collection of blood (haematoma) in the groin as a complication of the cardiac procedure where a catheter is inserted in your leg artery (pseudoaneurysm)

Not known (frequency cannot be estimated from the available data)

- kidney failure after a severe bleeding
- increased pressure within muscles of the legs or arms after a bleeding, which leads to pain, swelling, altered sensation, numbness or paralysis (compartment syndrome after a bleeding)

Side effects in children and adolescents

In general, the side effects observed in children and adolescents treated with Xarelto were similar in type to those observed in adults and were primarily mild to moderate in severity.

Side effects that were observed more often in children and adolescents:

Very common (may affect more than 1 in 10 people)

- Headache
- fever
- nose bleeding

- vomiting

Common (may affect up to 1 in 10 people)

- raised heartbeat
- blood tests may show an increase in bilirubin (bile pigment)
- thrombocytopenia (low number of platelets which are cells that help blood to clot)
- heavy menstrual bleeding

Uncommon (may affect up to 1 in 100 people)

- blood tests may show an increase in a subcategory of bilirubin (direct bilirubin, bile pigment)

Reporting of side effects

If you or the child get any side effects, talk to your doctor or pharmacist. This includes any possible side effects not listed in this leaflet. You can also report side effects directly via the Yellow Card Scheme, Website: <https://yellowcard.mhra.gov.uk> or search for MHRA Yellow Card in the Google Play or Apple App Store. By reporting side effects, you can help provide more information on the safety of this medicine.

5. How to store Xarelto

Keep this medicine out of the sight and reach of children.

Do not use this medicine after the expiry date which is stated on the carton and on the bottle after EXP.

The expiry date refers to the last day of that month.

After preparation, the shelf life of the suspension is 14 days at room temperature.

Do not store above 30 °C.

Do not freeze. Store the prepared suspension upright.

Do not throw away any medicines via wastewater or household waste. Ask your pharmacist how to throw away medicines you no longer use. These measures will help protect the environment.

6. Contents of the pack and other information

What Xarelto contains

- The active substance is rivaroxaban. One glass bottle contains 51.7 mg (for the 100 mL bottle) or 103.4 mg (for the 250 mL bottle) of rivaroxaban. After preparation, each mL of the suspension contains 1 mg of rivaroxaban.
- The other ingredients are:
Citric acid, anhydrous (E 330), hypromellose (2910), mannitol (E 421), microcrystalline cellulose, carboxymethylcellulose sodium, sodium benzoate (E 211) (see section 2 “Xarelto contains sodium benzoate and sodium”), sucralose (E 955), xanthan gum (E 415), flavour sweet and creamy (consist of flavouring substances, maltodextrin (maize), propylene glycol (E 1520) and acacia gum (E 414)).

What Xarelto looks like and contents of the pack

Xarelto granules for oral suspension are white granules in a glass bottle with child resistant screw cap.

Pack sizes

- For children weighing **less than 4 kg**:
Folding box with one brown glass bottle (100 mL) containing 2.625 g granules (corresponding to 51.7 mg rivaroxaban), two 1 mL blue syringes, one 50 mL water syringe and one adapter.

- For children weighing **4 kg or more**:
Folding box with one brown glass bottle (250 mL) containing 5.25 g granules (corresponding to 103.4 mg rivaroxaban), two 5 mL and two 10 mL blue syringes, one 100 mL water syringe and one adapter.

Not all pack sizes may be marketed.

The individual weight-adjusted dose volume and frequency should be specified by the prescriber. It should be written on the outer carton when provided to the parents, caregivers or patients.

Please follow carefully the Instructions for Use booklet which is provided in each pack.

Watch the educational video which you can access via the QR code which is displayed on the Patient Alert Card that is provided with this medicine.

Marketing Authorisation Holder and Manufacturer

Bayer AG
51368 Leverkusen
Germany

For any information about this medicine, please contact the local representative of the Marketing Authorisation Holder:

United Kingdom

Bayer plc
Tel: +44-(0) 118 206 3000

This leaflet was last revised in January 2021

Detailed information on this medicine is available on the European Medicines Agency website:
<http://www.ema.europa.eu>.

Instructions for Use (IFU)

Instructions for Use

Xarelto 1 mg/mL

100 mL bottle with 2.625 g granules for preparation of oral suspension

Active pharmaceutical ingredient: Rivaroxaban

Preparation and administration of the oral suspension (granules-water-mixture)

Glossary and symbols

- Granules: powder (provided in the bottle) which contains active pharmaceutical ingredient
- Water syringe: 50 mL syringe used to measure and add 50 mL of water to the bottle containing Xarelto granules.
- Suspension: granules-water-mixture (for oral application)
- Blue syringe: syringe with blue plunger to extract and orally administer Xarelto.



Caution: Consult Instructions for Use for relevant information related to warnings and precautions.



Consult Instructions for Use (IFU).



Keep away from sunlight



Protect from moisture



Manufacturing date



Expiry date



Reference number

LOT

Batch number



For oral use only

Before you start

- Read all sections of the Instructions for Use carefully before using Xarelto for the first time and before administering each dose.
- Watch the educational video which you can access via the QR code displayed on the Patient Alert Card that is provided with this medicine.
- Be sure you understand the instructions before starting. If not, call your doctor.
- Further information regarding Xarelto can be found in the Package Leaflet

Packaging contents

Every Xarelto box contains the following components:



1 bottle with child resistant screw cap containing Xarelto granules.



1 packaged 50 mL water syringe (for single use only)

The water syringe is used to extract the exact quantity of water required to prepare Xarelto suspension.



1 packaged bottle adapter

The adapter is inserted into the neck of the bottle containing Xarelto granules after the exact quantity of water is added to the bottle. This bottle adapter connects the blue syringe to the bottle to ensure the correct amount of suspension can be extracted from the bottle into the blue syringe.

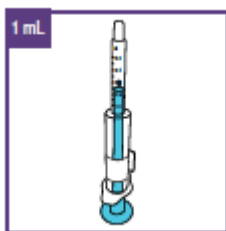

2 packaged 1 mL blue syringes (one is a spare syringe):

This blue syringe is used to administer volumes up to **1 mL**

Use the appropriate blue syringe for the volume of suspension that is to be administered.

The blue syringes have a **red** button under the label. This button serves to fix the required dosing volume.

Keep the label at this place on the blue syringe until instructed to remove it.



1 Instructions for Use (IFU) (this document)

The IFU contains a description of the preparation of the suspension and how the blue syringe is set up and handled.



1 Package Leaflet

Provides important information about Xarelto.



1 Patient Alert Card

Important information in case of emergency.

To be kept with the patient at all times and presented to every physician or dentist prior to treatment



Cautionary Information:

Do not unpack the single components until the instructions tell you to do so.

Do not use Xarelto if any of the parts have been opened or are damaged.

Do not use Xarelto after the expiry date which is stated on the box.

Warnings and precautions

- **Only** use non-carbonated drinking water to prepare the suspension to avoid bubbles. That means you can use either
 - fresh tap water or
 - non-carbonated (still) mineral water
- It is very important that the precise amount of water is added to the granules in the bottle to ensure the correct concentration of Xarelto.
 - Use the water syringe for measurement of 50 mL water, see below for more information.

- Measure the amount water to be provided to the bottle very carefully.
- After preparation the suspension can be used for 14 days if stored at room temperature. Ensure to write the expiry date of the suspension (date of preparation plus 14 days) on the dedicated field on the bottle label.
- **Do not** store the suspension above 30 °C. **Do not** freeze.
If the suspension has been stored in the refrigerator, allow the suspension to adjust to room temperature before extracting the relevant dose.
- Shake the suspension for initial preparation **for at least 60 seconds**.
- Shake the suspension in the bottle **for at least 10 seconds** before each administration.
- It is very important that the prescribed dose volume of Xarelto is being administered.
 - Make sure that you know the prescribed dose and frequency of administration. Ask your doctor or pharmacist if you do not know the prescribed dose and frequency.
 - Carefully adjust the blue syringe according the prescribed volume.
 - Administer the prescribed dose by using the blue syringe. Follow the doctor's instructions on how often per day you should administer the prescribed dose.
 - Check for air bubbles in the blue syringe before administration of the oral suspension.
- If your child repeatedly does not take all the required dose or spits some of it out, call your child's doctor to find out what to do.
- Between dosing, store the oral suspension out of sight and reach of children.
- Keep the Instructions for Use so that you can refer to them later during the use of Xarelto.

Using Xarelto

- Xarelto suspension is for oral use only.
- Volume and frequency of administration of Xarelto depend on your child's weight, so it will change over time if your child will receive Xarelto for a longer time.
 - Your child's doctor will tell you the right dose volume .
 - **Do not change the dose yourself.**
 - **Always** use the volume prescribed by your child's doctor and have the correct dosing of administration written on the designated field on the outside of the box.
If it is not written on the field, ask your child's doctor or pharmacist to provide the relevant information.
- Follow the detailed Instructions for Use given in the chapters below.
- Take care to comply with the instructions concerning administration:
 - Intake: Three times a day
 - Administration: Approximately 8 hours apart with feeding

1. Preparing the oral suspension

Step 1.1: Preparation – Get ready

The preparation of the suspension is done once with every new package.
Before preparing the suspension:



a. Thoroughly wash your hands with soap and dry them afterwards



b. Check the expiry date on the label provided on the box.
Do not use the medicine if the medicine has expired.

c. Obtain the following additional items:

- Container with at least 150 mL of water:
 - Either fresh tap water or non-carbonated (still) mineral water
 - Water should be at room temperature
- Tissue for soaking up any excess water

Step 1.2: Filling the required volume of water

Every time you start a new pack, use only the new materials contained in the new package.



a. Unpack the water syringe.

b. Dip the opening of the water syringe into the container with water.

c. Extract a volume of more than 50 mL.

To do this, pull the plunger rod towards you, and make sure that the opening of the water syringe stays below the water surface all the time. This will avoid air bubbles in the syringe.

d. Take the syringe out of the water.

- e. Turn the water syringe in a way that the opening is facing upwards.
 → Any air bubbles will move to the top when holding the syringe upwards.
 Tap it with your fingers to further move any air bubble to the top.

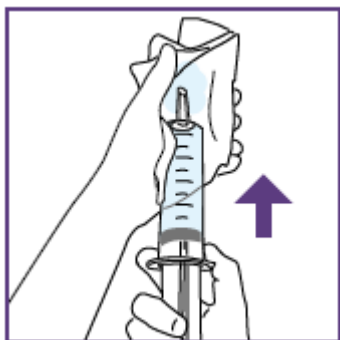

- f. Push the plunger rod until the upper ring of the plunger reaches the 50 mL mark.
 → When pressing the plunger, water can come out of the tip of the water syringe. This waste water can be soaked up with a tissue.

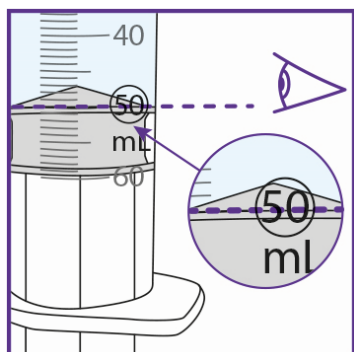

	Cautionary Information:
--	--------------------------------

The upper ring of the black plunger **must be precisely in line with the 50 mL** mark to be able to achieve the correct concentration of the suspension.

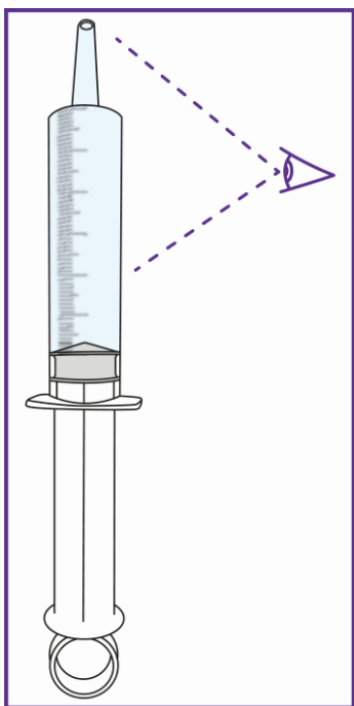

- g. Continue to hold the water syringe with the opening facing upwards and check the water in the syringe carefully:
- for correct volume,
 - for air bubbles.
- Small air bubbles are uncritical, but big air bubbles are critical. See below for more explanation on what to do.

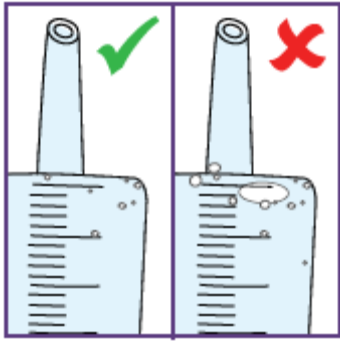

h. **If the syringe is not loaded correctly or contains too much air:**

- Empty the water syringe
- Repeat steps b. to h

Step 1.3: Adding water to the granules

a. **If the granules in the bottle appear to be clumpy:**

- Gently tap the bottle on your hand.
- **Be careful** since the bottle is made of glass.



b. Unscrew the child resistant cap of the bottle (push down and turn counterclockwise).

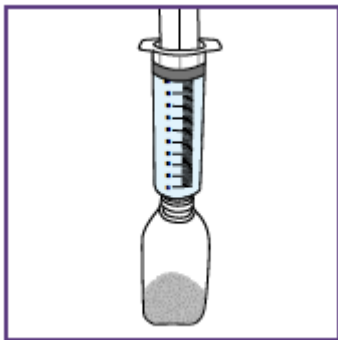

c. Place the filled water syringe on the upper edge of the bottle opening

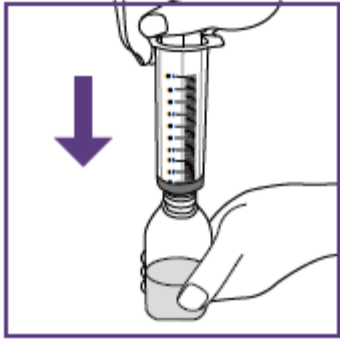

- d. Hold the bottle firmly.
- e. Press the plunger rod down slowly.
The full volume of water must be transferred to the bottle.
- f. Dispose of the water syringe in household waste.

Step 1.4: Fitting the adapter and mixing the oral suspension

The adapter is used to fill the blue syringe with suspension.

- a. Unpack the bottle adapter
- b. Push the adapter completely into the neck of the bottle

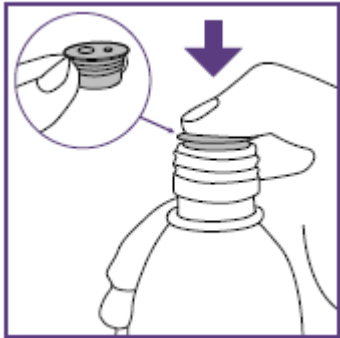

- c. Close the bottle tightly with the screw cap.



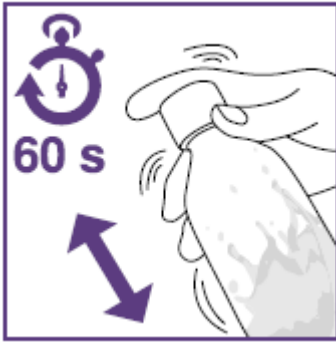

- d. Shake the bottle **gently** for **at least 60 seconds**.
 → This is intended to provide a well-mixed suspension.

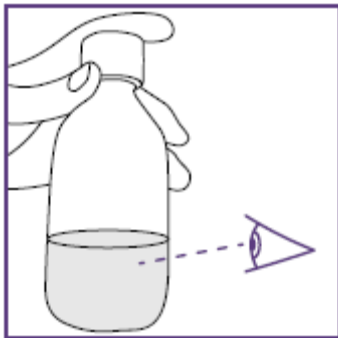

- e. Check whether the suspension is thoroughly mixed:
- no clumps
 - no deposit.

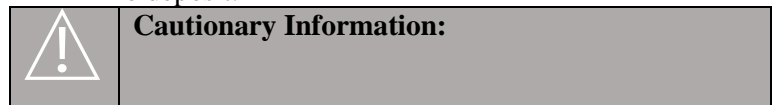

To guarantee correct dose, the suspension must **not** contain **any** clumps or deposit.

- f. **If there are clumps or sediment** repeat steps d. to f.

→ When no clumps or deposits are left, the suspension is ready for use.

Do not add more water to the bottle.

The suspension has a shelf life of 14 days at room temperature.



- g. Write the date of expiry of the just prepared suspension on the label of the bottle.

Date of preparation + 14 days

The shown pictogram is only an example.

2. Setting the prescribed dose with every new blue syringe

To prevent overdosing or underdosing an exact dose of suspension is required.

Before you take the first dose out of the bottle, the enclosed blue syringe must be set up in accordance with the dose prescribed by your child's doctor. This information can be found on the dedicated area of the box. If no information has been entered here check back with the child's doctor or pharmacist.

After setting the dose the same blue syringe can be used for all administrations from the bottle of suspension prepared in step 1.

Once the dose has been fixed on the blue syringe, it cannot be changed.

The blue syringe features a scale (mL).
The scale of the 1 mL blue syringe starts with 0.2 mL.
The graduation marks are in increments of 0.1 mL.

Note:

Do not remove the peelable label until you are prompted in the Instructions for Use.

The blue syringe features a **red** button to adjust the volume. This button is initially covered by a peelable label.

By pressing the red button the volume of the syringe is set, which can only be done once. **Do not** press the **red** button until the Instructions for Use tell you to do so.

Once the **red** button has been pressed, the volume can no longer be adjusted.



- a. Review the dose provided in the respective field on the outside of the box.

- b. **If the information is not available:**

Ask your pharmacist or doctor to provide it.

- c. Hold the blue syringe with the opening pointing upwards

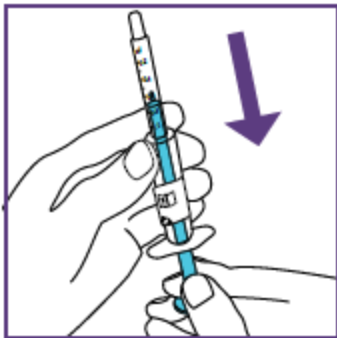

- d. Pull the plunger rod **slowly** until the upper margin reaches the mark of the volume to be administered.

→ When moving the plunger rod, you can hear a “Click” for each adjustable volume step.

	Cautionary Information:
--	--------------------------------

The upper edge of the plunger **must be exactly in line** with the correct mark of the volume to be administered.

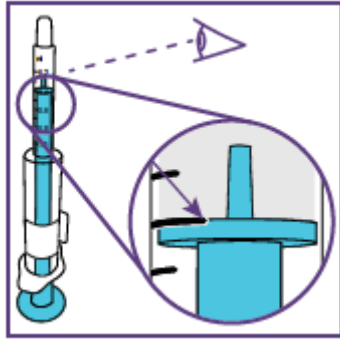

The shown pictogram is only an example. Your volume might be different.

Be careful, do not pull the plunger past the volume to be administered.

Be careful, do not press on the label when pulling the plunger.

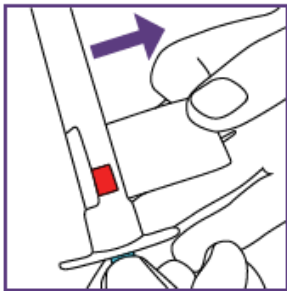

e. Remove the label of the blue syringe **completely**.

→ You can now see the **red** button for setting the volume.

f. Check the position of the plunger again. Ensure the upper edge of the plunger is exactly in line with the correct mark of the volume to be administered.

g. **If the position of the blue plunger does not match the required volume:**

Adjust it accordingly

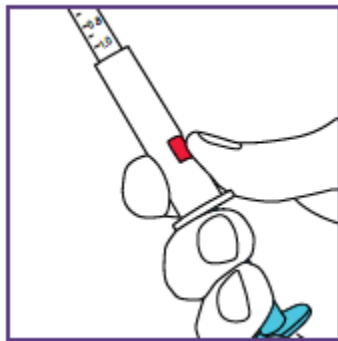

h. If the position of the blue plunger matches the required volume, push the **red** button to fix the adjustment.

→ The required dose is now set.

→ Pressing the red button will produce another clicking sound.

The clicking sound will not be audible afterwards.

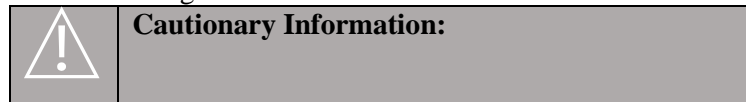

If you notice that the wrong dose has been selected (the red button has been pushed, when the plunger was in the wrong position) use the appropriate spare blue syringe. Repeat steps a. to h. with a new blue syringe.

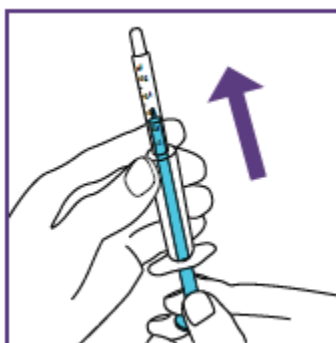

i. Push the plunger upwards in the blue syringe as far as it goes.

The blue syringe can now be used.

3. Administering the oral suspension

Follow the steps described below for each required administration.

Step 3.1: Mixing the oral suspension



Cautionary Information:

Allow the suspension to adjust to room temperature if it has been stored in the refrigerator.



a. **Gently** shake the bottle for **at least 10 seconds** before each dose.

→ This is intended to provide a well-mixed suspension.

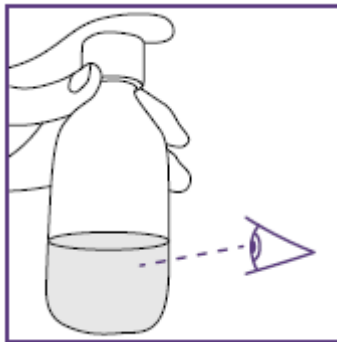

b. Check whether the suspension is mixed thoroughly, i.e.:

- no clumps
- no deposit.

c. **If there are clumps or deposit:**
Repeat steps a. and b.

d. Shaking can lead to formation of foam.
Let the bottle stand until the foam dissolves.



e. Unscrew the bottle cap, but keep the adapter on the top of the bottle.

Note:

The larger opening visible on the adapter is used to connect the blue syringe.

The surface of the bottle adapter should be free of liquid.

f. **If there is any liquid on the adapter:**

Remove the liquid with a clean tissue

Step 3.2: Extracting the required dose

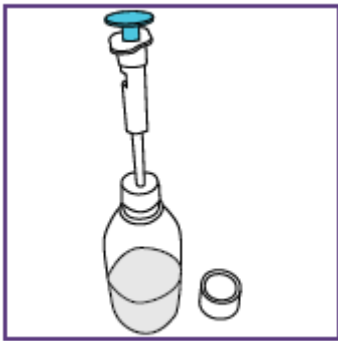

a. Keep the bottle in the upright position. Insert the tip of the blue syringe **fully** into the large opening of the adapter

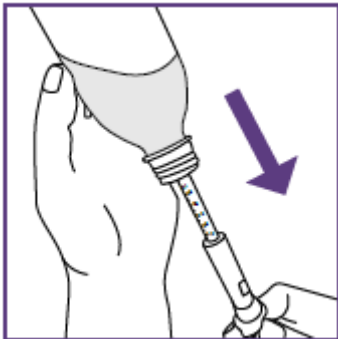

b. Turn the bottle upside down.

c. Pull the blue plunger rod **slowly** until it stops (i.e. until the set dose is reached).

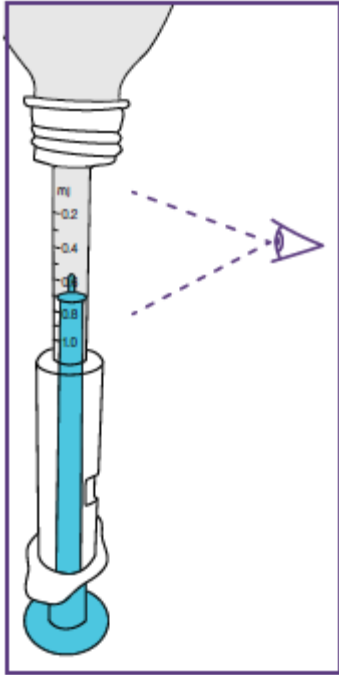

d. Carefully check for air in the blue syringe. Smaller air bubbles are not critical.

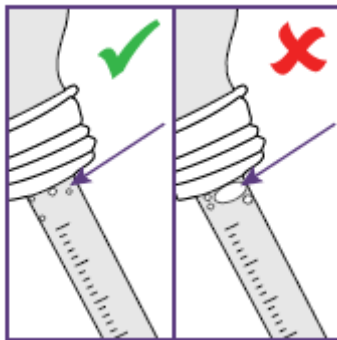

e. **If there are bigger air bubbles:**

- Return the suspension to the bottle by pushing back the plunger rod into the blue syringe as far as possible.
- Repeat steps b. to e.

f. Return the bottle to the upright position.

g. Remove the blue syringe **carefully** from the adapter

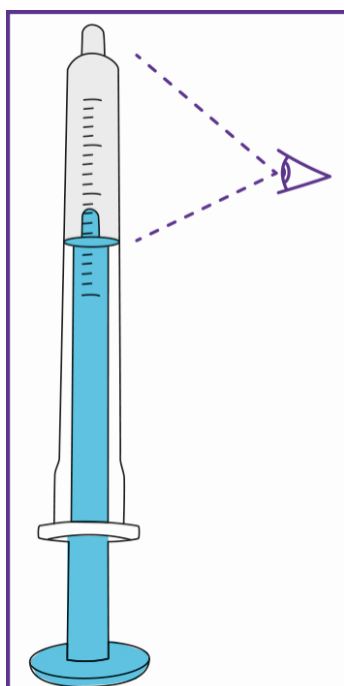

h. Hold the blue syringe upright and check:

- that the tip of the blue syringe is filled
- whether the right dose has been filled into the blue syringe
- that no big air bubbles are present.

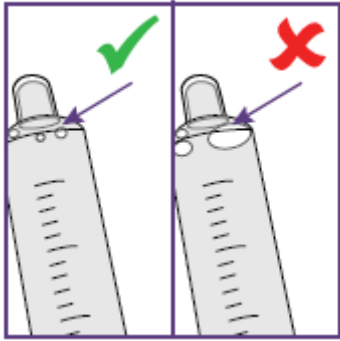

i. If there are bigger air bubbles or air in the tip:

- Insert the tip of the blue syringe again fully into the large opening of the adapter
- Return the suspension to the bottle by pushing back the plunger rod into the blue syringe as far as it goes.
- Repeat steps b. to h. until no bigger air bubbles are visible.

j. Close the bottle with the screw cap.

Administer the suspension immediately after filling the blue syringe (step 3.3)

Step 3.3: Administration of prescribed dose

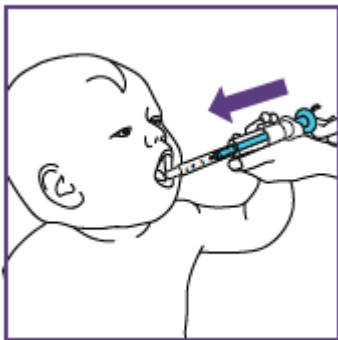

- a. Place the blue syringe into the mouth of the patient.
- b. Direct its tip into the cheek to allow for natural swallowing.
- c. Push the plunger rod down **slowly** until the plunger stops (blue syringe is completely empty).
- d. Ensure that the patient swallows the entire dose.



Cautionary Information:

The patient must swallow the full dose of medicine.

If the dose repeatedly is not completely swallowed or if the patient is vomiting, consult your doctor for further instructions.



- e. Encourage the patient to drink one typical serving of liquid.
 - For an infant of 6 months, for example, this may be 20 mL.
 - This can also be breast-feeding.

4. Cleaning and storage

The blue syringe must be cleaned following every application.

Follow the steps listed below to clean the device. Altogether, **three** cycles of cleaning are necessary to ensure proper cleaning.

Before you start, you will need the following equipment for step 4.1:

- Get two containers (such as a cup or bowl)
 - one container filled with drinking water,
 - the other container empty

Step 4.1: Cleaning



- a. Dip the tip of the blue syringe into the container of water.
- b. Withdraw water until plunger rod stops.



- c. Empty the blue syringe into the prepared empty container

- d. Repeat steps a. to c. an **additional two times**.
- e. After cleaning, push the plunger rod back in until it stops.
- f. Dry the outer surface of the syringe with a clean tissue



Cautionary Information:

- Do not clean the blue syringe in the dish washer.
- Never boil the blue syringe.

Step 4.2: Storage

Store the blue syringe in a clean and dry place until next use, e.g. keep it in the box Xarelto was given to you.
Keep away from sunlight.



Cautionary Information:

The blue syringe **can be used for up to 14 days**.

Store the suspension below 30 °C.

**Cautionary Information:**

Do not freeze the suspension.

The prepared suspension is stable at room temperature for up to 14 days (preparation date plus 14 days).

Keep Xarelto out of the sight and reach of children.

Store the prepared suspension upright.

5. Disposal

Any unused medicine or waste material should be disposed of in accordance with local requirements.

Instructions for Use (IFU)

Instructions for Use

Xarelto 1 mg/mL

250 mL bottle with 5.25 g granules for preparation of oral suspension

Active pharmaceutical ingredient: Rivaroxaban

Preparation and administration of the oral suspension (granules-water-mixture)

Glossary and symbols

- Granules: powder (provided in the bottle) which contains active pharmaceutical ingredient
- Water syringe: 100 mL syringe used to measure and add 100 mL of water to the bottle containing Xarelto granules.
- Suspension: granules-water-mixture (for oral application)
- Blue syringe: syringe with blue plunger to extract and orally administer Xarelto.



Caution: Consult Instructions for Use for relevant information related to warnings and precautions.



Consult Instructions for Use (IFU).



Keep away from sunlight



Protect from moisture



Manufacturing date



Expiry date



Reference number



Batch number



For oral use only

Before you start

- Read all sections of the Instructions for Use carefully before using Xarelto for the first time and before administering each dose.
- Watch the educational video which you can access via the QR code displayed on the Patient Alert Card that is provided with this medicine.
- Be sure you understand the instructions before starting. If not, call your doctor.
- Further information regarding Xarelto can be found in the Package Leaflet

Packaging contents

Every Xarelto box contains the following components:



1 bottle with child resistant screw cap containing Xarelto granules.



1 packaged 100 mL water syringe (for single use only)

The water syringe is used to extract the exact quantity of water required to prepare Xarelto suspension.



1 packaged bottle adapter

The adapter is inserted into the neck of the bottle containing Xarelto granules after the exact quantity of water is added to the bottle. This bottle adapter connects the blue syringe to the bottle to ensure the correct amount of suspension can be extracted from the bottle into the blue syringe.

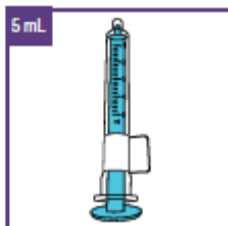

2 packaged 5 mL blue syringes (one is a spare syringe) :

This blue syringe is used to administer volumes up to **5 mL**

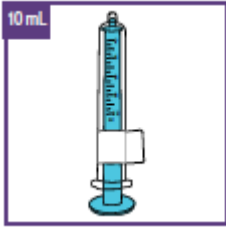

2 packaged 10 mL blue syringes (one is a spare syringe):

This blue syringe is used to administer volumes of **5 mL** up to **10 mL**.

Use the appropriate blue syringe for the volume of suspension that is to be administered.

The blue syringes have a **red** button under the label. This button serves to fix the required dosing volume.

Keep the label at this place on the blue syringe until instructed to remove it.



1 Instructions for Use (IFU) (this document)

The IFU contains a description of the preparation of the suspension and how the blue syringe is set up and handled.



1 Package Leaflet

Provides important information about Xarelto.



1 Patient Alert Card

Important information in case of emergency.

To be kept with the patient at all times and presented to every physician or dentist prior to treatment



Cautionary Information:

Do not unpack the single components until the instructions tell you to do so.

Do not use Xarelto if any of the parts have been opened or are damaged.

Do not use Xarelto after the expiry date which is stated on the box.

Warnings and precautions

- **Only** use non-carbonated drinking water to prepare the suspension to avoid bubbles. That means you can use either
 - fresh tap water or
 - non-carbonated (still) mineral water
- It is very important that the precise amount of water is added to the granules in the bottle

to ensure the correct concentration of Xarelto.

- Use the water syringe for measurement of 100 mL water, see below for more information.
- Measure the amount water to be provided to the bottle very carefully.
- After preparation the suspension can be used for 14 days if stored at room temperature. Ensure to write the expiry date of the suspension (date of preparation plus 14 days) on the dedicated field on the bottle label.
- **Do not** store the suspension above 30 °C. **Do not** freeze.
If the suspension has been stored in the refrigerator, allow the suspension to adjust to room temperature before extracting the relevant dose.
- Shake the suspension for initial preparation **for at least 60 seconds**.
- Shake the suspension in the bottle **for at least 10 seconds** before each administration.
- It is very important that the prescribed dose volume of Xarelto is being administered.
 - Make sure that you know the prescribed dose and frequency of administration. Ask your doctor or pharmacist if you do not know the prescribed dose and frequency.
 - Carefully adjust the blue syringe according the prescribed volume.
 - Administer the prescribed dose by using the blue syringe. Follow the doctor's instructions on how often per day you should administer the prescribed dose.
 - Check for air bubbles in the blue syringe before administration of the oral suspension.
- If your child repeatedly does not take all the required dose or spits some of it out, call your child's doctor to find out what to do.
- Between dosing, store the oral suspension out of sight and reach of children.
- Keep the Instructions for Use so that you can refer to them later during the use of Xarelto.

Using Xarelto

- Xarelto suspension is for oral use only.
- Volume and frequency of administration of Xarelto depend on your child's weight, so it will change over time if your child will receive Xarelto for a longer time.
 - Your child's doctor will tell you the right dose volume and the frequency of administration.
 - **Do not change the dose yourself.**
 - **Always** use the volume prescribed by your child's doctor and have the correct dosing and frequency of administration written on the designated field on the outside of the box.
If it is not written on the field, ask your child's doctor or pharmacist to provide the relevant information.
- Follow the detailed Instructions for Use given in the chapters below.
- Take care to comply with the instructions concerning administration:

Intake	Administration time point	Time span between administrations
once a day	with feeding or with a meal	approximately 24 hours apart
twice a day		approximately 12 hours apart
three times a day		approximately 8 hours apart

1. Preparing the oral suspension

Step 1.1: Preparation – Get ready

The preparation of the suspension is done once with every new package.
Before preparing the suspension:



a. Thoroughly wash your hands with soap and dry them afterwards.



b. Check the expiry date on the label provided on the box.
Do not use the medicine if the medicine has expired.

c. Obtain the following additional items:

- Container with at least 150 mL of water:
 - Either fresh tap water or non-carbonated (still) mineral water
 - Water should be at room temperature
- Tissue for soaking up any excess water

Step 1.2: Filling the required volume of water

Every time you start a new pack, use only the new materials contained in the new package.

a. Unpack the water syringe.



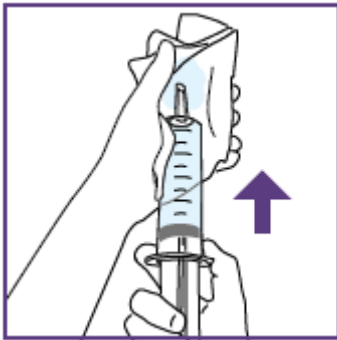

- b. Dip the opening of the water syringe into the container with water.
- c. Extract a volume of more than 100 mL.
To do this, pull the plunger rod towards you, and make sure that the opening of the water syringe stays below the water surface all the time. This will avoid air bubbles in the syringe.
- d. Take the syringe out of the water.

- e. Turn the water syringe in a way that the opening is facing upwards.
→ Any air bubbles will move to the top when holding the syringe upwards.
Tap it with your fingers to further move any air bubble to the top.

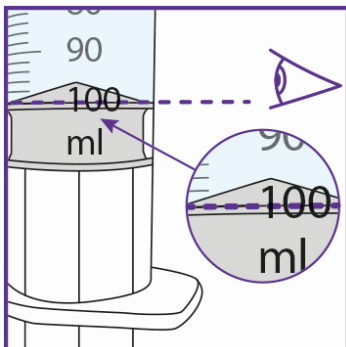

- f. Push the plunger rod until the upper ring of the plunger reaches the 100 mL mark.
→ When pressing the plunger, water can come out of the tip of the water syringe. This waste water can be soaked up with a tissue.



	Cautionary Information:
---	--------------------------------

The upper ring of the black plunger **must be precisely in line with the 100 mL** mark to be able to achieve the correct concentration of the suspension.

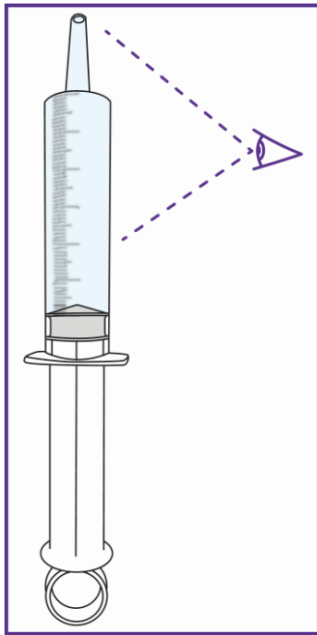

g. Continue to hold the water syringe with the opening facing upwards and check the water in the syringe carefully:

- for correct volume,
- for air bubbles.

Small air bubbles are uncritical, but big air bubbles are critical. See below for more explanation on what to do.

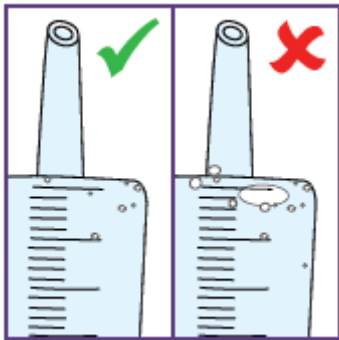

h. **If the syringe is not loaded correctly or contains too much air:**

- Empty the water syringe
- Repeat steps b. to h

Step 1.3: Adding water to the granules

a. **If the granules in the bottle appear to be clumpy:**

- Gently tap the bottle on your hand.
- **Be careful** since the bottle is made of glass.

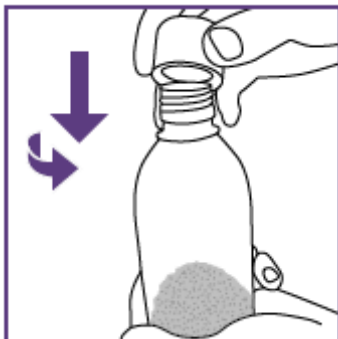

b. Unscrew the child resistant cap of the bottle (push down and turn counterclockwise).

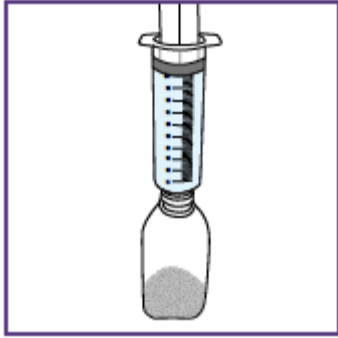

c. Place the filled water syringe on the upper edge of the bottle opening

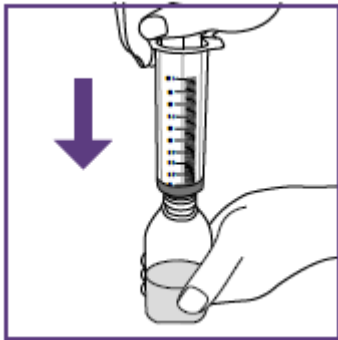

- d. Hold the bottle firmly.
- e. Press the plunger rod down slowly.
The full volume of water must be transferred to the bottle.
- f. Dispose of the water syringe in household waste.

Step 1.4: Fitting the adapter and mixing the oral suspension

The adapter is used to fill the blue syringe with suspension.

- a. Unpack the bottle adapter
- b. Push the adapter completely into the neck of the bottle

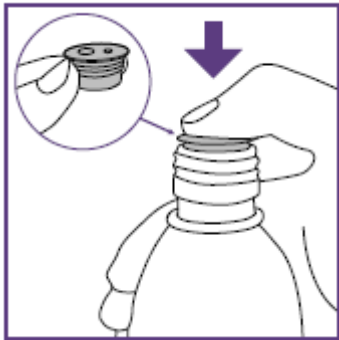



c. Close the bottle tightly with the screw cap.

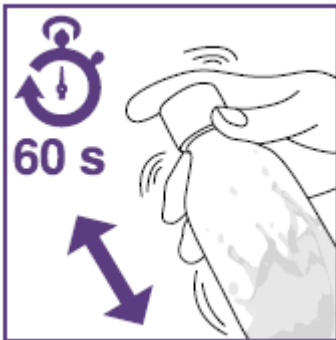

d. Shake the bottle **gently** for **at least 60 seconds**.
→ This is intended to provide a well-mixed suspension.

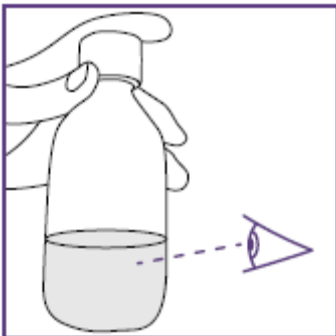

e. Check whether the suspension is thoroughly mixed:

- no clumps
- no deposit.



Cautionary Information:

To guarantee correct dose, the suspension must **not** contain **any** clumps or deposit.

f. If there are **clumps or sediment** repeat steps d. to f.

→ When no clumps or deposits are left, the suspension is ready for use.

Do not add more water to the bottle.

The suspension has a shelf life of 14 days at room temperature.



- g. Write the date of expiry of the just prepared suspension on the label of the bottle.

Date of preparation + 14 days

The shown pictogram is only an example.

2. Setting the prescribed dose with every new blue syringe

To prevent overdosing or underdosing an exact dose of suspension is required.

Before you take the first dose out of the bottle, the enclosed blue syringe must be set up in accordance with the dose prescribed by your child's doctor. This information can be found on the dedicated area of the box. If no information has been entered here check back with the child's doctor or pharmacist.

After setting the dose the same blue syringe can be used for all administrations from the bottle of suspension prepared in step 1.

Once the dose has been fixed on the blue syringe, it cannot be changed.

Step 2.1: Selecting a suitable blue syringe

Dosing devices with different capacities are included in this pack:

5 mL blue syringes for doses from **1 mL to 5 mL**

10 mL blue syringes for doses from **5 mL to 10 mL**

- Select the suitable blue syringe based on the dose prescribed by your child's doctor.
The other blue syringes are not needed.
- Unpack the blue syringe.

Note:

Do not remove the peelable label until you are prompted in the Instructions for Use.

The blue syringe features a **red** button to adjust the volume. This button is initially covered by a peelable label.

By pressing the red button the volume of the syringe is set, which can only be done once. **Do not** press the **red** button until the Instructions for Use tell you to do so.

Once the **red** button has been pressed, the volume can no longer be adjusted.

Step 2.2: Setting the required dose on new blue syringe

The blue syringe features a scale (mL).

The scale of the 5 mL blue syringe starts with 1 mL. The graduation marks are in increments of 0.2 mL.

The scale of the 10 mL blue syringe starts with 2 mL. The graduation marks are in increments of 0.5 mL.



- a. Review the dose provided in the respective field on the outside of the box.

Note:

Use the 10 mL blue syringe for prescribed doses larger than 10 mL as follows:

Dose of 15 mL: 2 x 7.5 mL blue syringe

Dose of 20 mL: 2 x 10 mL blue syringe

- b. **If the information is not available:**

Ask your pharmacist or doctor to provide it.

- c. Hold the blue syringe with the opening pointing upwards

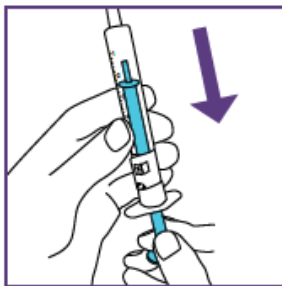

- d. Pull the plunger rod **slowly** until the upper margin reaches the mark of the volume to be administered.

→ When moving the plunger rod, you can hear a “Click” for each adjustable volume step.

	Cautionary Information:
--	--------------------------------

The upper edge of the plunger **must be exactly in line** with the correct mark of the volume to be administered.

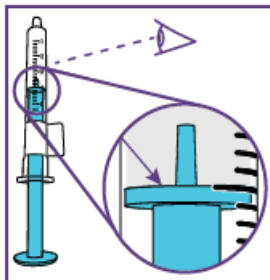

The shown pictogram is only an example. Your volume might be different.

Be careful, do not pull the plunger past the volume to be administered.

Be careful, do not press on the label when pulling the plunger.

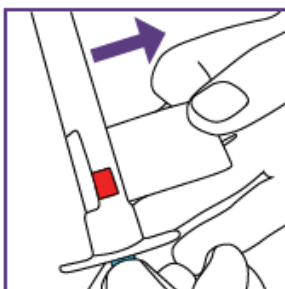

- e. Remove the label of the blue syringe **completely**.

→ You can now see the **red** button for setting the volume.

- f. Check the position of the plunger again. Ensure the upper edge of the plunger is exactly in line with the correct mark of the volume to be administered.

- g. **If the position of the blue plunger does not match the required volume:**

Adjust it accordingly

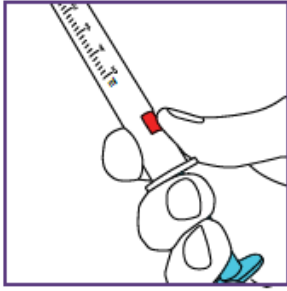

- h. If the position of the blue plunger matches the required volume, push the **red** button to fix the adjustment.
- The required dose is now set.
 - Pressing the red button will produce another clicking sound.
 - The clicking sound will not be audible afterwards.



Cautionary Information:

If you notice that the wrong dose has been selected (the red button has been pushed, when the plunger was in the wrong position) use the appropriate spare blue syringe. Repeat steps a. to h. with a new blue syringe.

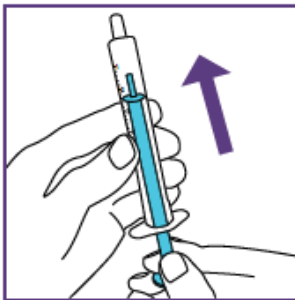

- i. Push the plunger upwards in the blue syringe as far as it goes. The blue syringe can now be used.

3. Administering the oral suspension

Follow the steps described below for each required administration.

Step 3.1: Mixing the oral suspension



Cautionary Information:

Allow the suspension to adjust to room temperature if it has been stored in the refrigerator.



- a. **Gently** shake the bottle for **at least 10 seconds** before each dose.
- This is intended to provide a well-mixed suspension.

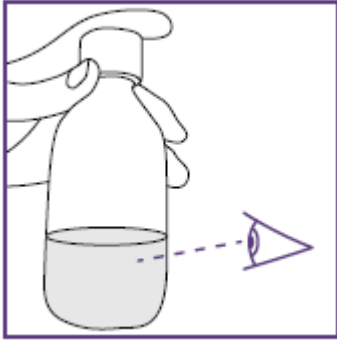

b. Check whether the suspension is mixed thoroughly, i.e.:

- no clumps
- no deposit.

c. If there are clumps or deposit:

Repeat steps a. and b.

d. Shaking can lead to formation of foam.

Let the bottle stand until the foam dissolves.

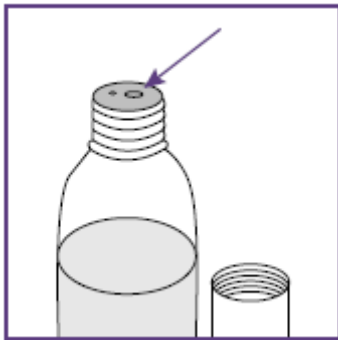

e. Unscrew the bottle cap, but keep the adapter on the top of the bottle.

Note:

The larger opening visible on the adapter is used to connect the blue syringe.

The surface of the bottle adapter should be free of liquid.

f. If there is any liquid on the adapter:

Remove the liquid with a clean tissue

Step 3.2: Extracting the required dose

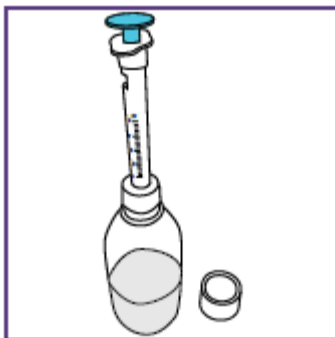

a. Keep the bottle in the upright position. Insert the tip of the blue syringe **fully** into the large opening of the adapter

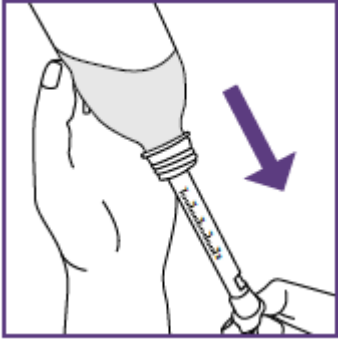

- b. Turn the bottle upside down.
c. Pull the blue plunger rod **slowly** until it stops (i.e. until the set dose is reached).

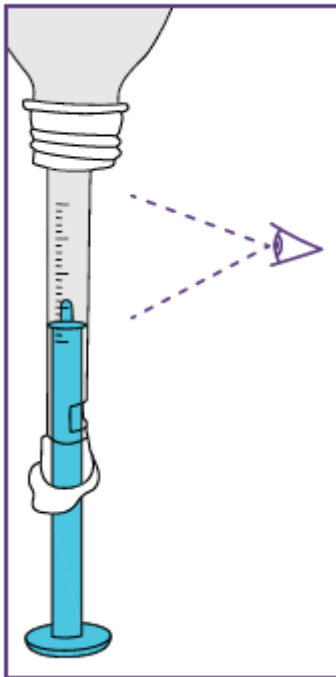

- d. Carefully check for air in the blue syringe. Smaller air bubbles are not critical.

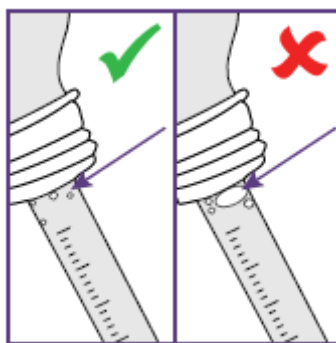

- e. **If there are bigger air bubbles:**
- Return the suspension to the bottle by pushing back the plunger rod into the blue syringe as far as possible.
 - Repeat steps b. to e.
- f. Return the bottle to the upright position.
g. Remove the blue syringe **carefully** from the adapter

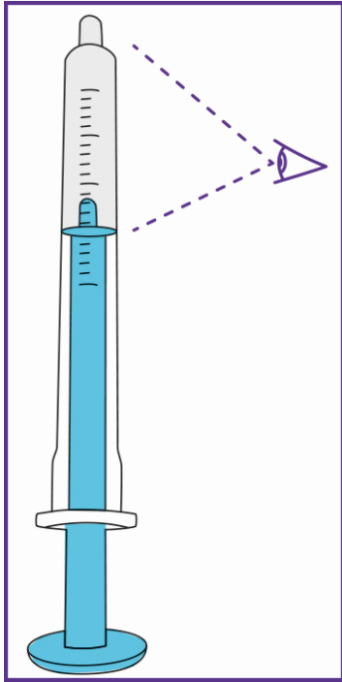

- h. Hold the blue syringe upright and check:
- that the tip of the blue syringe is filled
 - whether the right dose has been filled into the blue syringe
 - that no big air bubbles are present.

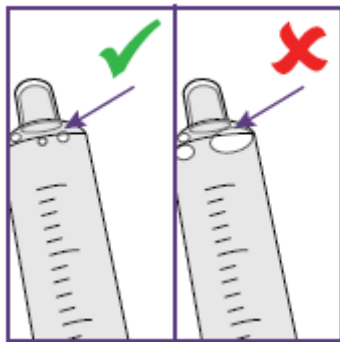

- i. **If there are bigger air bubbles or air in the tip:**
- Insert the tip of the blue syringe again fully into the large opening of the adapter
 - Return the suspension to the bottle by pushing back the plunger rod into the blue syringe as far as it goes.
 - Repeat steps b. to h. until no bigger air bubbles are visible.

- j. Close the bottle with the screw cap.
Administer the suspension immediately after filling the blue syringe (step 3.3)

Step 3.3: Administration of prescribed dose

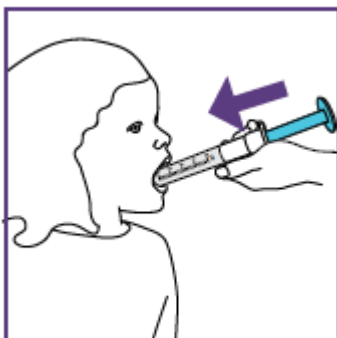

- Place the blue syringe into the mouth of the patient.
- Direct its tip into the cheek to allow for natural swallowing.
- Push the plunger rod down **slowly** until the plunger stops (blue syringe is completely empty).
- Ensure that the patient swallows the entire dose.



Cautionary Information:

The patient must swallow the full dose of medicine.

If the dose repeatedly is not completely swallowed or if the patient is vomiting, consult your doctor for further instructions.



- e. Encourage the patient to drink one typical serving of liquid.
- For an infant of 6 months, for example, this may be 20 mL.
 - This can also be breast-feeding.
 - For an adolescent it may be a volume up to 240 mL

4. Cleaning and storage

The blue syringe must be cleaned following every application.

Follow the steps listed below to clean the device. Altogether, **three** cycles of cleaning are necessary to ensure proper cleaning.

Before you start, you will need the following equipment for step 4.1:

- Get two containers (such as a cup or bowl)
 - one container filled with drinking water,
 - the other container empty

Step 4.1: Cleaning

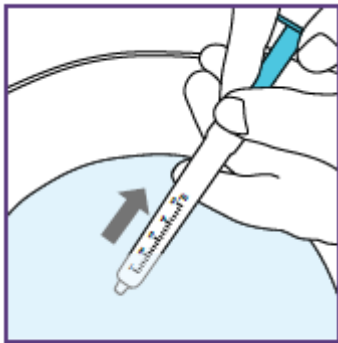

- a. Dip the tip of the blue syringe into the container of water.
b. Withdraw water until plunger rod stops.



- c. Empty the blue syringe into the prepared empty container

- d. Repeat steps a. to c. an **additional two times**.
- e. After cleaning, push the plunger rod back in until it stops.
- f. Dry the outer surface of the syringe with a clean tissue

	Cautionary Information:
<ul style="list-style-type: none"> ▪ Do not clean the blue syringe in the dish washer. ▪ Never boil the blue syringe. 	

Step 4.2: Storage

Store the blue syringe in a clean and dry place until next use, e.g. keep it in the box Xarelto was given to you.

Keep away from sunlight.

	Cautionary Information:
---	--------------------------------

The blue syringe **can be used for up to 14 days**.

Store the suspension below 30 °C.

	Cautionary Information:
---	--------------------------------

Do not freeze the suspension.

The prepared suspension is stable at room temperature for up to 14 days (preparation date plus 14 days).

Keep Xarelto out of the sight and reach of children.

Store the prepared suspension upright.

5. Disposal

Any unused medicine or waste material should be disposed of in accordance with local requirements.