

Package leaflet: Information for the user

Buvidal 8 mg prolonged-release solution for injection
Buvidal 16 mg prolonged-release solution for injection
Buvidal 24 mg prolonged-release solution for injection
Buvidal 32 mg prolonged-release solution for injection
Buvidal 64 mg prolonged-release solution for injection
Buvidal 96 mg prolonged-release solution for injection
Buvidal 128 mg prolonged-release solution for injection
Buvidal 160 mg prolonged-release solution for injection

buprenorphine

Read all of this leaflet carefully before you start receiving this medicine because it contains important information for you.

- Keep this leaflet. You may need to read it again.
- If you have any further questions, ask your doctor, pharmacist or nurse.
- If you get any side effects, talk to your doctor, pharmacist or nurse. This includes any possible side effects not listed in this leaflet. See section 4.

What is in this leaflet

1. What Buvidal is and what it is used for
2. What you need to know before you receive Buvidal
3. How Buvidal is given
4. Possible side effects
5. How to store Buvidal
6. Contents of the pack and other information

1. What Buvidal is and what it is used for

Buvidal contains the active substance buprenorphine, which is a type of opioid medicine. It is used to treat opioid dependence in patients who are also receiving medical, social and psychological support. Buvidal is intended for use in adults and adolescents aged 16 years or over.

2. What you need to know before you receive Buvidal

You must not receive Buvidal

- if you are allergic to buprenorphine or any of the other ingredients of this medicine (listed in section 6)
- if you have serious breathing problems
- if you have serious liver problems
- if you are intoxicated with alcohol or have trembling, sweating, anxiety, confusion or hallucinations caused by alcohol

Warnings and precautions

Talk to your doctor before receiving Buvidal if you have:

- asthma or other breathing problems
- any liver disease such as hepatitis
- severe kidney impairment
- certain heart rhythm conditions (long QT syndrome or prolonged QT interval)
- low blood pressure

- recently suffered a head injury or brain disease
 - a urinary disorder (especially linked to enlarged prostate in men)
 - thyroid problems
 - an adrenocortical disorder (e.g. Addison's disease)
 - gall bladder problems
 - depression or other conditions that are treated with antidepressants.
- The use of these medicines together with Buvidal can lead to serotonin syndrome, a potentially life-threatening condition (see "Other medicines and Buvidal").
- if you have ever had an allergic reaction to latex.

Important things to be aware of

- **Breathing problems:** Some people have died from very slow or shallow breathing caused by taking buprenorphine with other central nervous system depressants (substances that slow down some brain activity) such as benzodiazepines, alcohol or other opioids.
- **Drowsiness:** This medicine may cause drowsiness especially when used with alcohol or other central nervous system depressants (substances that slow down some brain activity) such as benzodiazepines, other medicines that reduce anxiety or cause sleepiness, pregabalin or gabapentin.
- **Dependence:** This medicine can cause dependence.
- **Liver damage:** Liver damage can occur with buprenorphine, especially when it is misused. It can also occur because of viral infections (chronic hepatitis C), alcohol abuse, anorexia (eating disorder) or use of other medicines which harm your liver. Your doctor may ask you to have regular blood tests to check your liver. Tell your doctor if you have any liver problems before you start treatment with Buvidal.
- **Withdrawal symptoms:** This medicine can cause withdrawal symptoms if you take it less than 6 hours after you use a short-acting opioid (e.g. morphine, heroin) or less than 24 hours after you use a long-acting opioid such as methadone.
- **Blood pressure:** This medicine may cause your blood pressure to drop suddenly, causing you to feel dizzy if you get up too quickly from sitting or lying down.
- **Diagnosis of unrelated medical conditions:** This medicine may mask pain and make it difficult to diagnose some diseases. Do not forget to tell your doctor that you are being treated with this medicine.
- **Sleep-related breathing disorders:** Buvidal can cause sleep-related breathing disorders such as sleep apnoea (breathing pauses during sleep) and sleep related hypoxemia (low oxygen level in the blood). The symptoms can include breathing pauses during sleep, night awakening due to shortness of breath, difficulties to maintain sleep or excessive drowsiness during the day. If you or another person observe these symptoms, contact your doctor. A dose reduction may be considered by your doctor.

Children and adolescents

Buvidal is not for use in children below 16 years of age. You will be more closely monitored by your doctor if you are an adolescent (16-17 years old).

Other medicines and Buvidal

Tell your doctor if you are taking, have recently taken or might take any other medicines. Some medicines may increase the side effects of Buvidal and may cause very serious reactions.

It is especially important to tell your doctor if you are taking:

- **benzodiazepines** (used to treat anxiety or sleep disorders). Taking too much of a benzodiazepine together with Buvidal may lead to death because both medicines can cause very slow and shallow breathing (respiratory depression). If you need a benzodiazepine, your doctor will prescribe the correct dose.
- **gabapentinoids (gabapentin or pregabalin)** (used to treat epilepsy or neuropathic pain). Taking too much of a gabapentinoid may lead to death because both medicines can cause very

slow and shallow breathing (respiratory depression). You must use the dose that your doctor has prescribed for you.

- **alcohol or medicines containing alcohol.** Alcohol can worsen the sedative effect of this medicine.
- **other medicines that may make you feel sleepy** which are used to treat illnesses such as anxiety, sleeplessness, convulsions (fits) and pain. These medicines when taken together with Buvidal can slow down some brain activity and reduce alertness and how well you will drive and use machines.

Examples of medicines that can make you feel sleepy or less alert include:

- other opioids such as methadone, certain painkillers and cough medicines. These medicines may also increase the risk of opioid overdose
- antidepressants (used to treat depression)
- sedative antihistamines (used to treat allergic reactions)
- barbiturates (used to cause sleep or sedation)
- certain anxiolytics (used to treat anxiety disorders)
- antipsychotics (used to treat psychiatric disorders such as schizophrenia)
- clonidine (used to treat high blood pressure)
- **opioid painkillers.** These medicines may not work properly when taken together with Buvidal and they may increase the risk of overdose.
- **naltrexone and nalmefene** (used to treat addiction disorders) as they can stop Buvidal from working properly. You should not take them at the same time as this medicine.
- **certain antiretrovirals** (used to treat HIV infection) such as ritonavir, nelfinavir or indinavir as they may increase the effects of this medicine.
- **certain antifungal medicines** (used to treat fungal infections) such as ketoconazole, itraconazole as they may increase the effects of this medicine.
- **macrolide antibiotics** (used to treat bacterial infections) such as clarithromycin and erythromycin as they may increase the effects of this medicine.
- **certain antiepileptic medicines** (used to treat epilepsy) such as phenobarbital, carbamazepine and phenytoin as they may decrease the effect of Buvidal.
- **rifampicin** (used to treat tuberculosis). Rifampicin may decrease the effect of Buvidal.
- **monoamine oxidase inhibitors** (used to treat depression) such as phenelzine, isocarboxazid, iponiazid and tranylcypromine as they may increase the effects of this medicine.
- **anti-depressants** such as moclobemide, tranylcypromine, citalopram, escitalopram, fluoxetine, fluvoxamine, paroxetine, sertraline, duloxetine, venlafaxine, amitriptyline, doxepine, or trimipramine. These medicines may interact with Buvidal and you may experience symptoms such as involuntary, rhythmic contractions of muscles, including the muscles that control movement of the eye, agitation, hallucinations, coma, excessive sweating, tremor, exaggeration of reflexes, increased muscle tension, body temperature above 38°C. Contact your doctor when experiencing such symptoms.

Buvidal with alcohol

Do not take alcohol while using Buvidal (see section 2 warnings and precautions). Taking alcohol with this medicine may increase drowsiness and may increase the risk of breathing problems.

Pregnancy and breast-feeding

If you are pregnant or breast-feeding, think you may become pregnant or are planning to have a baby, ask your doctor for advice before you are given this medicine. The risks of using Buvidal in pregnant women are not known. Your doctor will help you decide if you should continue taking the medicine during pregnancy.

Using this medicine during late pregnancy may cause drug withdrawal symptoms including breathing problems in your new-born baby. This may happen from several hours to several days after birth.

Check with your doctor before using Buvidal during breastfeeding as this medicine passes into breast milk.

Driving and using machines

The medicine can affect your ability to drive as it may make you sleepy or dizzy. This is more likely at the start of treatment and when your dose is being changed. These effects can be worse if you drink alcohol or take other sedative medicines.

- Do not drive while taking this medicine until you know how it affects you.
- It is an offence to drive if this medicine affects your ability to drive.
- However, you would not be committing an offence if:
 - the medicine has been prescribed to treat a medical or dental problem and
 - you have taken it according to the instructions given by the prescriber or in the information provided with the medicine and
 - it was not affecting your ability to drive safely.

Talk to your doctor or pharmacist if you are not sure whether it is safe for you to drive while taking this medicine.

Buvidal contains alcohol

Buvidal 8 mg, 16 mg, 24 mg and 32 mg contain 95.7 mg of alcohol (ethanol) in each mL (10% w/w). The amount in 1 dose of this medicine is equivalent to less than 2 mL beer or 1 mL wine. The small amount of alcohol in this medicine will not have any noticeable effects.

3. How Buvidal is given

Buvidal must be given by healthcare professionals only.

Buvidal 8 mg, 16 mg, 24 mg and 32 mg are given weekly. Buvidal 64 mg, 96 mg, 128 mg and 160 mg are given monthly.

Your doctor will determine the best dose for you. During your treatment, the doctor may adjust the dose, depending on how well the medicine works.

Starting treatment

The first dose of Buvidal will be given to you when you show clear signs of withdrawal.

If you are dependent on short-acting opioids (e.g. morphine or heroin), the first dose of Buvidal will be given to you at least 6 hours after you last used an opioid.

If you are dependent on long-acting opioids (e.g. methadone), your dose of methadone will be reduced to below 30 mg per day before beginning with Buvidal. The first dose of this medicine will be given to you at least 24 hours after you last used methadone.

If you are not already receiving sublingual (under the tongue) buprenorphine (the same active substance as in Buvidal), the recommended starting dose is 16 mg, with one or two additional Buvidal 8 mg doses given at least 1 day apart during the first treatment week. This means a target dose of 24 mg or 32 mg during the first treatment week.

If you have not used buprenorphine before you will receive a 4 mg sublingual buprenorphine dose and be observed for an hour before the first Buvidal dose.

Buvidal for monthly treatment can be used, if appropriate for you, once stabilisation has been achieved with Buvidal for weekly treatment (four weeks treatment or more, where practical).

If you are already taking sublingual buprenorphine, you can start receiving Buvidal the day after your last treatment. Your doctor will prescribe the correct starting dose of Buvidal for you depending on the dose of sublingual buprenorphine you are now taking.

Continuing treatment and dose adjustment

During continued treatment with Buvidal, your doctor may decrease or increase your dose according to your need. You may be switched from weekly and monthly treatment and from monthly to weekly treatment. Your doctor will prescribe the correct dose for you.

During continued treatment, you might receive one additional Buvidal 8 mg dose between your weekly or monthly treatments if your doctor thinks this is appropriate for you.

The maximum dose per week if you are on weekly Buvidal treatment is 32 mg with an additional 8 mg dose. The maximum dose per month if you are on monthly Buvidal treatment is 160 mg.

Route of administration

Buvidal is given as a single injection under the skin (subcutaneously) in any of the allowed injection areas buttock, thigh, abdomen or upper arm. You can receive several injections in the same injection area, but the exact injection sites will be different for each weekly and monthly injection for a minimum period of 8 weeks.

If you use more buprenorphine than you should

If you have received more buprenorphine than you should you need to contact your doctor immediately since this can cause very slow and shallow breathing which can lead to death.

If you use too much buprenorphine, you must immediately seek medical attention as overdose may cause serious and life-threatening breathing problems. Symptoms of overdose may include breathing more slowly and weakly, feeling more sleepy than normal, feeling sick, vomiting and/or having slurred speech or difficulty talking. You may also have smaller pupils. If you start to feel faint, this may be a sign of low blood pressure.

If you miss a dose of Buvidal

It is very important to keep all your appointments to receive Buvidal. If you miss an appointment, ask your doctor when to schedule your next dose.

If you stop using Buvidal

Do not stop treatment without checking with the doctor who is treating you. Stopping treatment may cause withdrawal symptoms.

If you have any further questions on the use of this product, ask your doctor.

4. Possible side effects

Like all medicines, this medicine can cause side effects, although not everybody gets them.

Tell your doctor immediately or get urgent medical attention if you have side effects such as:

- sudden wheezing, difficulty breathing, swelling of the eyelids, face, tongue, lips, throat or hands; rash or itching especially over your whole body. These may be signs of a life-threatening allergic reaction.
- if you start to breathe more slowly or weakly than usual (respiratory depression).
- if you start to feel faint, as this may be a sign of low blood pressure.

Also tell your doctor immediately if you get side effects such as:

- severe tiredness, have no appetite or if your skin or eyes look yellow. These may be symptoms of liver damage.

Other side effects:

Very common side effects (may affect more than 1 in 10 people):

- Insomnia (inability to sleep)
- Headache

- Nausea (feeling sick)
- Sweating, drug withdrawal syndrome, pain

Common side effects (may affect up to 1 in 10 people):

- Infection, influenza, sore throat and painful swallowing, runny nose
- Swollen glands (lymph nodes)
- Hypersensitivity
- Decreased appetite
- Anxiety, agitation, depression, hostility, nervousness, abnormal thinking, paranoia
- Sleepiness, feeling dizzy, migraine, burning or tingling in hands and feet, fainting, tremor, increase in muscle tension, speech disorders
- Watery eyes, abnormal widening or narrowing of the pupil (the dark part of the eye)
- Palpitations
- Low blood pressure
- Cough, shortness of breath, yawning, asthma, bronchitis
- Constipation, vomiting (being sick), belly pain, flatulence (wind), indigestion, dry mouth, diarrhoea
- Rash, itching, hives
- Joint pain, back pain, muscle pain, muscle spasms, neck pain, bone pain
- Painful period
- Injection site reactions e.g. pain, itching, red skin, swelling and hardening of skin
- Swelling of the ankles, feet or fingers, weakness, feeling unwell, fever, chills, drug withdrawal syndrome in the new-born, chest pain
- Abnormal liver test results

Uncommon side effects (may affect up to 1 in 100 people):

- Skin infection at the injection site
- A feeling of dizziness or spinning (vertigo)

Not known (frequency cannot be estimated from the available data):

- Hallucinations, feeling happiness and excitement (euphoria)
- Abnormal redness of the skin
- Painful or difficult urination
- Injection site reactions e.g. open sores, a swollen area with collected pus, discolouration caused by death of cells or tissue at the injection site.

Reporting of side effects

If you get any side effects, talk to your doctor. This includes any possible side effects not listed in this leaflet. You can also report side effects directly via:

Yellow Card Scheme

Website: www.mhra.gov.uk/yellowcard

or search MHRA Yellow Card in the Google Play or Apple App Store

By reporting side effects you can help provide more information on the safety of this medicine.

5. How to store Buidal

Buidal is for administration of healthcare professionals only. Take-home use or self-administration of the product by patients is not allowed.

Keep this medicine out of the sight and reach of children.

Do not use this medicine after the expiry date which is stated on the carton or the syringe label after EXP. The expiry date refers to the last day of that month.

Do not refrigerate or freeze.

Do not use this medicine if you notice visible particles or if it is cloudy.

Buidal is for single use only. Any used syringe should be discarded.

Do not throw away any medicines via wastewater or household waste. Ask your pharmacist how to throw away medicines you no longer use. These measures will help protect the environment.

6. Contents of the pack and other information

What Buvidal contains

- The active substance is buprenorphine
- The other ingredients are soybean phosphatidylcholine, glycerol dioleate, ethanol anhydrous (see section 2 Buvidal contains alcohol) (only in weekly formulation) and N-methylpyrrolidone (only in monthly formulation).

The following syringes are available:

Weekly injection:

- 8 mg: Pre-filled syringe containing 8 mg buprenorphine in 0.16 mL solution
- 16 mg: Pre-filled syringe containing 16 mg buprenorphine in 0.32 mL solution
- 24 mg: Pre-filled syringe containing 24 mg buprenorphine in 0.48 mL solution
- 32 mg: Pre-filled syringe containing 32 mg buprenorphine in 0.64 mL solution

Monthly injection:

- 64 mg: Pre-filled syringe containing 64 mg buprenorphine in 0.18 mL solution
- 96 mg: Pre-filled syringe containing 96 mg buprenorphine in 0.27 mL solution
- 128 mg: Pre-filled syringe containing 128 mg buprenorphine in 0.36 mL solution
- 160 mg: Pre-filled syringe containing 160 mg buprenorphine in 0.45 mL solution

What Buvidal looks like and contents of the pack

Buvidal is a prolonged-release solution for injection. Each pre-filled syringe contains a yellowish to yellow clear liquid.

The following pack sizes are available:

Pre-filled syringes containing 8 mg, 16 mg, 24 mg, 32 mg, 64 mg, 96 mg, 128 mg and 160 mg solution for injection.

Each pack contains 1 pre-filled syringe with stopper, needle, needle shield, safety device and 1 plunger rod.

Marketing Authorisation Holder

Camurus AB
Ideon Science Park
SE-223 70 Lund
Sweden
medicalinfo@camurus.com

Manufacturer

Rechon Life Science AB
Soldatorpsvägen 5
216 13 Limhamn
Sweden

This leaflet was last revised in 03/2024

The following information is intended for healthcare professionals only:

Instructions for Use for Healthcare Professionals

Contents:

1. **Important information**
2. **Safety syringe parts**
3. **Administration**
4. **Disposing of the syringe**

1. Important information

- Injection should be made into the subcutaneous tissue. Do not use if the safety syringe is broken or the packaging is damaged.
- The needle shields of the safety syringe may contain rubber latex that may cause allergic reactions in latex-sensitive individuals.
- Handle the safety syringe carefully to avoid a needle stick. The safety syringe includes a needle protection safety device that will activate at the end of the injection. The needle protection will help to prevent needle stick injuries.
- Do not uncap the safety syringe until you are ready to inject. Once uncapped never try to recap the needle.
- Dispose of the used safety syringe right away after use. Do not reuse the safety syringe.

2. Safety syringe parts

Safety syringe parts

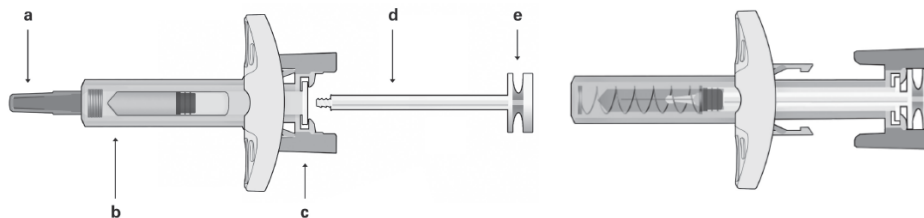

Figure 1 Safety syringe: before use

- a) Needle shield
- b) Syringe guard body
- c) Syringe guard wings
- d) Plunger
- e) Plunger head

Safety syringe: after use

(with needle protection mechanism activated)

Please note that the smallest injection volume is barely visible in the viewing window as the spring of the safety device “cover” part of the glass cylinder close to the needle.

- Do not touch the syringe guard wings until you are ready to inject. By touching them, the syringe guard may be activated too early.
- Do not use the product if it has been dropped on a hard surface or damaged. Use a new product for the injection.

3. Administration

- Take the syringe out of the cardboard box: pick up the syringe by the syringe guard body.
- While holding a firm grip on the syringe by the inspection window, insert the plunger rod into the plunger stopper by gently rotating the plunger rod clockwise until secured (see Figure 2).

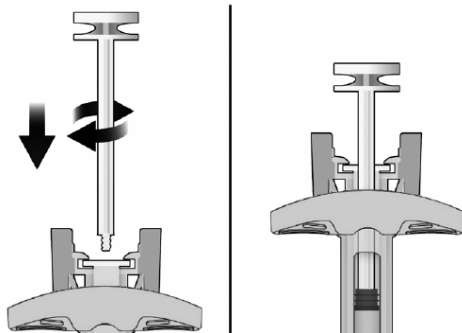

Figure 2 Before

After

- Inspect the safety syringe closely:
 - Do not use the safety syringe after the expiry date shown on the cardboard box or on the syringe label.
 - A small air bubble may be seen, which is normal.
 - The liquid should be clear. Do not use the safety syringe if the liquid contains particles or is cloudy.
- Choose the injection site. Injections should be rotated between sites in the buttock, thigh, abdomen, or upper arm (see Figure 3) with a minimum of 8 weeks before re-injecting a previously used injection site. Injections on the waistline or within 5 cm of the navel should be avoided.

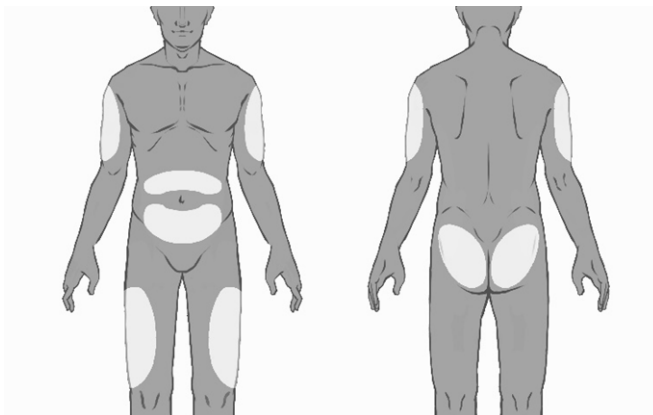

Figure 3

- Put on gloves and clean the injection site with a circular motion using an alcohol wipe (not provided in the pack). Do not touch the cleaned area again before injecting.
- While holding the safety syringe by the syringe guard body as shown (see Figure 4), carefully pull the needle shield straight off. Immediately dispose of the needle shield (never try to recap the needle). A drop of liquid may be seen at the end of the needle. This is normal.

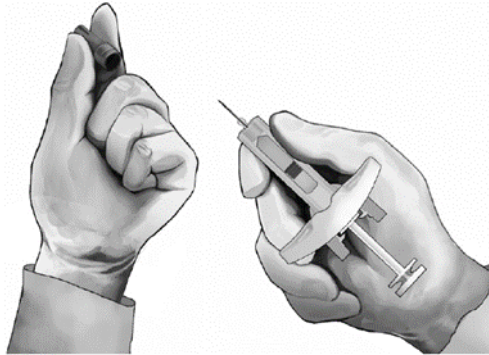

Figure 4

- Pinch the skin at the injection site between the thumb and finger as shown (see Figure 5).
- Hold the safety syringe as shown and insert the needle at an angle of approximately 90° (see Figure 5). Push the needle all the way in.

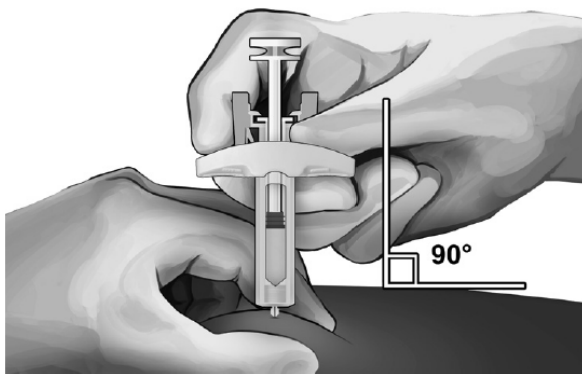

Figure 5

- While holding the syringe as shown (see Figure 6), slowly depress the plunger until the plunger head latches between the syringe guard wings and all the solution is injected.

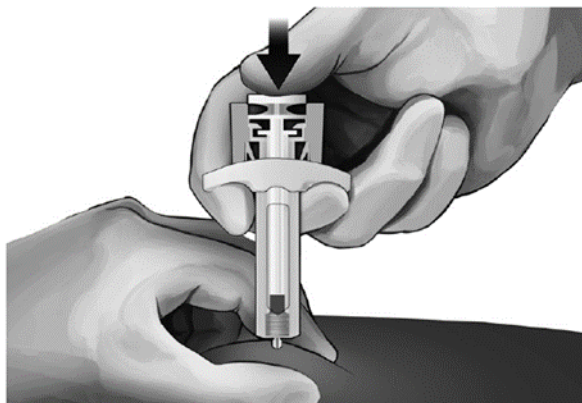

Figure 6

- Gently pull the needle out of the skin. It is recommended that the plunger is kept fully depressed while the needle is carefully lifted straight out from the injection site (see Figure 7).

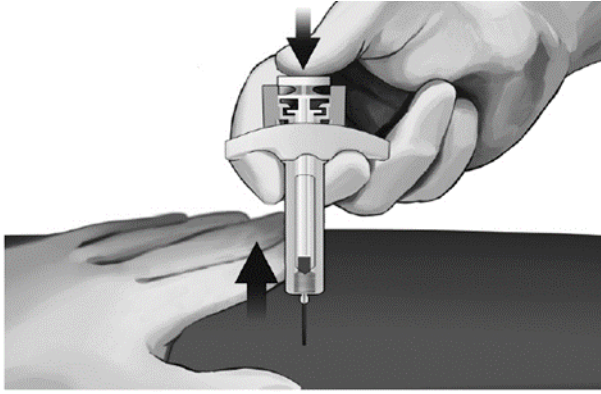

Figure 7

- As soon as the needle has been completely removed from the skin, slowly take the thumb off the plunger and allow the syringe guard to automatically cover the exposed needle (see Figure 8). There may be a small amount of blood at the injection site, if required wipe with a cotton ball or gauze.



Figure 8

4. Disposing of the syringe

Any unused medicinal product or waste material should be disposed of in accordance with local requirements.