

Package leaflet: Information for the user

NeoRecormon 500 IU
NeoRecormon 2000 IU
NeoRecormon 3000 IU
NeoRecormon 4000 IU
NeoRecormon 5000 IU
NeoRecormon 6000 IU
NeoRecormon 10,000 IU
NeoRecormon 20,000 IU
NeoRecormon 30,000 IU
solution for injection in pre-filled syringe
epoetin beta

Read all of this leaflet carefully before you start using this medicine because it contains important information for you.

- Keep this leaflet. You may need to read it again.
- If you have any further questions, ask your doctor or pharmacist.
- This medicine has been prescribed for you only. Do not pass it on to others. It may harm them, even if their signs or illness are the same as yours.
- If you get any side effects, talk to your doctor or pharmacist. This includes any possible side effects not listed in this leaflet. See section 4.

What is in this leaflet

1. What NeoRecormon is and what it is used for
2. What you need to know before you use NeoRecormon
3. How to use NeoRecormon
4. Possible side effects
5. How to store NeoRecormon
6. Content of the pack and other information

1. What NeoRecormon is and what it is used for

NeoRecormon is a clear, colourless solution for injection under the skin (*subcutaneously*) or into a vein (*intravenously*). It contains a hormone called *epoetin beta*, which stimulates the production of red blood cells. Epoetin beta is produced by a specialised genetic technology and works in exactly the same way as the natural hormone erythropoietin.

You must talk to your doctor if you do not feel better or if you feel worse.

NeoRecormon is indicated for:

- **Treating symptomatic anaemia caused by chronic kidney disease** (renal anaemia) in patients on dialysis, or not yet on dialysis.
- **Preventing anaemia in premature infants** (weighing 750 to 1500 g and born at less than 34 weeks).
- **Treating anaemia with related symptoms in adult cancer patients receiving chemotherapy**
- **Treating people donating their own blood before surgery.** The injections of epoetin beta will increase the amount of blood that can be taken from your body before surgery and given back during or after the operation (this is an *autologous transfusion*).

2. What you need to know before you use NeoRecormon

Do not use NeoRecormon

- **if you are allergic** to epoetin beta or any of the other ingredients of this medicine (listed in section 6)
- **if you have blood pressure problems** that cannot be controlled
- **if you are donating your own blood before surgery, and:**
 - you had a **heart attack** or **stroke** in the month before your treatment
 - you have unstable **angina pectoris** – new or increasing chest pain
 - you are **at risk of blood clots** in the veins (deep venous thrombosis) – for example, if you have had clots before.

If any of these apply to you, or might apply, **tell your doctor at once.**

Warnings and precautions

Talk to your doctor before using NeoRecormon

- **if your baby needs treatment with NeoRecormon, your baby will be carefully monitored for any potential effects on the eye**
- **if your anaemia does not improve** with epoetin treatment
- **if you are low in certain B vitamins** (*folic acid or vitamin B12*)
- **if you have very high levels of aluminium** in your blood
- **if your blood platelet count is high**
- **if you have chronic liver disease**
- **if you have epilepsy**
- **if you have developed anti-erythropoietin antibodies and pure red cell aplasia** (reduced or stopped production of red blood cells) during prior exposure to any erythropoietic substance. In this case you should not be switched to NeoRecormon.

Take special care with other products that stimulate red blood cell production:

NeoRecormon is one of a group of products that stimulate the production of red blood cells like the human protein erythropoietin does. Your doctor will always record the exact product you are using.

Serious skin reaction including Stevens-Johnson syndrome (SJS) and toxic epidermal necrolysis (TEN) have been reported in association with epoetin treatment.

SJS/TEN can appear initially as reddish target-like spots or circular patches often with central blisters on the trunk. Also, ulcers of mouth, throat, nose, genitals and eyes (red and swollen eyes) can occur. These serious skin rashes are often preceded by fever and/or flu-like symptoms. The rashes may progress to widespread peeling of the skin and life-threatening complications.

If you develop a serious rash or another of these skin symptoms, stop taking NeoRecormon and contact your doctor or seek medical attention immediately.

Special Warning:

During treatment with NeoRecormon

If you are a patient with chronic kidney disease, and particularly if you do not respond properly to NeoRecormon, your doctor will check your dose of NeoRecormon because repeatedly increasing your dose of NeoRecormon if you are not responding to treatment may increase the risk of having a problem of the heart or the blood vessels and could increase risk of myocardial infarction, stroke and death.

If you are a cancer patient, you should be aware that NeoRecormon may act as a blood cell growth factor and in some circumstances may have a negative impact on your cancer. Depending on your individual situation, a blood transfusion may be preferable. Please discuss this with your doctor.

If you are a nephrosclerotic patient and you are not on dialysis, your doctor will decide whether treatment is right for you. This is because one cannot rule out a possible acceleration of progression of kidney disease with absolute certainty.

Your doctor may do regular blood tests to check:

- your potassium levels. If you have high or rising potassium levels your doctor may reconsider your treatment
- your blood platelet count. The number of platelets can rise slightly to moderately during epoetin treatment, and this can cause changes in blood clotting.

If you are a kidney patient under haemodialysis, your doctor may adjust your dose of heparin. This should avoid a blockage in the tubing of the dialysis system.

If you are a kidney patient under haemodialysis and at risk of shunt thrombosis, blood clots (thromboses) may form in your shunt (vessel used for connection to the dialysis system). Your doctor might prescribe acetylsalicylic acid or modify the shunt.

If you are donating your own blood before surgery, your doctor will need to:

- check that you are capable of giving blood, especially if you weigh less than 50 kg
- check that you have a sufficient level of red blood cells (*haemoglobin of at least 11 g/dL*)
- make sure that only 12% of your blood will be donated at once.

Do not misuse NeoRecormon:

Misuse of NeoRecormon by healthy people may lead to an increase in blood cells and consequently thicken the blood. This can in turn lead to life-threatening complications of the heart or blood vessels.

Other medicines and NeoRecormon

Tell your doctor or pharmacist if you are taking, have recently taken or might take any other medicines, including medicines obtained without a prescription.

Pregnancy, breast-feeding and fertility

There is not much experience with NeoRecormon in pregnant women or women who are breast-feeding. Ask your doctor or pharmacist for advice before taking any medicine. NeoRecormon has not shown evidence of impaired fertility in animals. The potential risk for humans is unknown.

Driving and using machines

No effects on ability to drive or use machines have been observed.

NeoRecormon contains phenylalanine and sodium

This medicine contains phenylalanine. May be harmful for people with phenylketonuria.

If you have *phenylketonuria*, **talk to your doctor** about your treatment with **NeoRecormon**.

This medicine contains less than 1 mmol sodium (23 mg) per dose, that is to say essentially 'sodium-free'.

3. How to use NeoRecormon

Always use this medicine exactly as your doctor has told you. Check with your doctor or pharmacist if you are not sure.

Your doctor will use the lowest effective dose to control the symptoms of your anaemia.

If you do not respond adequately to NeoRecormon, your doctor will check your dose and will inform you if you need to change doses.

Treatment must be started under the supervision of your doctor.
Further injections are given by your doctor or, after you have been trained, you can inject NeoRecormon yourself (see instructions at the end of this leaflet.)

NeoRecormon can be injected under the skin in the abdomen, arm or thigh, or into a vein. Your doctor will decide which is best for you.

Your doctor will carry out regular blood tests to monitor how your anaemia is responding to treatment by measuring your haemoglobin level.

NeoRecormon dosing

The dose of NeoRecormon depends on your disease condition, the way the injection is given (under the skin or into a vein) and your body weight. Your doctor will work out the right dose for you. Your doctor will use the lowest effective dose to control the symptoms of your anaemia.

If you do not respond adequately to NeoRecormon, your doctor will check your dose and will inform you if you need to change doses of NeoRecormon.

- **Symptomatic anaemia caused by chronic kidney disease**

Your injections are given under the skin or into a vein. If the solution is given into your vein it should be injected over about 2 minutes, e.g. people on haemodialysis will receive the injection via the arteriovenous fistula at the end of dialysis.

People who are not on haemodialysis will usually have injections under the skin.

Treatment with NeoRecormon is divided into two stages:

a) Correcting the anaemia

The initial dose for injections under the skin is 20 IU per injection for every 1 kg of your body weight, given three times per week.

After 4 weeks, the doctor will do tests and, if the treatment response is not sufficient, your dose may be raised to 40 IU/kg per injection, given three times per week. The doctor may continue to increase your dose at monthly intervals if necessary.

The weekly dose can also be divided into daily doses.

The initial dose for injections into veins is 40 IU per injection for every 1 kg of your body weight, given three times per week.

After 4 weeks, the doctor will do tests and, if the treatment response is not sufficient, your dose may be raised to 80 IU/kg per injection, given three times per week. The doctor may continue to increase your dose at monthly intervals if necessary.

For both types of injection, the maximum dose should not exceed 720 IU for every 1 kg of your body weight per week.

b) Maintaining sufficient red blood cell levels

The maintenance dose: Once your red blood cells reach an acceptable level, the dose is reduced to half the dose used to correct the anaemia. The weekly dose can be given once per week or divided into three or seven doses per week. If your red blood cell level is stable on a once weekly dosing regimen, your dose may be switched to once every two weeks administration. In this case dose increases may be necessary.

Every one or two weeks, the doctor may adjust your dose to find your individual maintenance dose.

Children will start by following the same guidelines. In trials, children usually needed higher doses of NeoRecormon (the younger the child, the higher the dose).

Treatment with NeoRecormon is normally a long-term therapy. However, it can be interrupted at any time, if necessary.

- **Anaemia in premature infants**

Injections are given under the skin.

The initial dose is 250 IU per injection for every 1 kg the infant weighs, three times a week.

Premature infants who have been transfused before the start of treatment with NeoRecormon are not likely to benefit as much as untransfused infants.

The recommended treatment duration is 6 weeks.

- **Adults with symptomatic anaemia receiving chemotherapy for cancer**

Injections are given under the skin.

Your doctor may initiate treatment with NeoRecormon if your haemoglobin level is 10 g/dL or less. After initiation of therapy, your doctor will maintain your haemoglobin level between 10 and 12 g/dL.

The initial weekly dose is 30,000 IU. This may be given as one injection per week, or in divided doses as 3 to 7 injections per week. **Your doctor will take regular blood samples.** He or she may raise or lower your dose or interrupt your treatment according to the test results. The haemoglobin values should not exceed a value of 12 g/dL.

The therapy should be continued for up to 4 weeks after the end of chemotherapy.

The maximum dose should not exceed 60,000 IU per week.

- **People donating their own blood before surgery**

Injections are given into a vein over 2 minutes, or under the skin.

The dose of NeoRecormon depends on your condition, red blood cell levels and how much blood will be donated before surgery.

The dose worked out by your doctor will be given twice per week for 4 weeks. When you donate blood, NeoRecormon will be given to you at the end of a donation session.

The maximum dose should not exceed

- for injections into veins: 1600 IU for every 1 kg of your body weight per week
- for injections under the skin: 1200 IU for every 1 kg of your body weight per week.

If you inject too much NeoRecormon

Do not increase the dose your doctor has given you. If you think you have injected more NeoRecormon than you should, contact your doctor. It is unlikely to be serious. Even at very high blood levels, no symptoms of poisoning have been observed.

If you forget to use NeoRecormon

If you have missed an injection, or injected too little, talk to your doctor.

Do not take a double dose to make up for any forgotten doses.

If you have any further questions on the use of this medicine, ask your doctor or pharmacist.

4. Possible side effects

Like all medicines, this medicine can cause side effects, although not everybody gets them.

Side effects which can affect any patient

- **Most people (very common may affect more than 1 in 10 people) get lower levels of iron in their blood.** Almost all patients have to be treated with iron supplements during their NeoRecormon therapy.
- **Rarely (may affect up to 1 in 1,000 people), allergies or skin reactions,** such as rash or hives, itching or reactions around the injection site have occurred.
- **Very rarely (may affect up to 1 in 10,000 people) a severe form of allergic reaction** has occurred, especially just after an injection. It needs to be treated at once. If you get **unusual wheezing or difficulty breathing; swollen tongue, face or throat, or swelling around the injection site; if you feel light-headed or faint or if you collapse, call your doctor at once.**
- **Very rarely (may affect up to 1 in 10,000 people) people experienced flu-like symptoms, especially when they just started treatment. These include** fever, chills, headaches, pain in the limbs, bone pain and/or feeling generally unwell. These reactions were usually mild to moderate and went away within a few hours or days.
- Serious skin rashes including Stevens-Johnson syndrome and toxic epidermal necrolysis have been reported in association with epoetin treatment. These can appear as reddish target-like macules or circular patches often with central blisters on the trunk, skin peeling, ulcers of mouth, throat, nose, genitals and eyes and can be preceded by fever and flu-like symptoms. Stop using NeoRecormon if you develop these symptoms and contact your doctor or seek medical attention immediately. See also section 2.

Additional side effects in people with chronic kidney disease (renal anaemia)

- **Increase in blood pressure, worsening of existing high blood pressure and headaches** are the most common side effects (very common may affect more than 1 in 10 people). Your doctor will regularly check your blood pressure, particularly at the beginning of therapy. Your doctor may treat the high blood pressure with drugs or temporarily interrupt your NeoRecormon therapy.
- **Call a doctor at once** if you get **headaches, especially sudden, stabbing, migraine-like headaches, confusion, speech disturbance, unsteady walking, fits or convulsions.** These may be signs of severely elevated blood pressure (*hypertensive crisis*), even if your blood pressure is usually normal or low. It needs to be treated at once.
- **If you have low blood pressure or shunt complications,** you may be at risk of *shunt thrombosis* (a blood clot in the vessel used for connection to the dialysis system).
- **Very rarely (may affect up to 1 in 10,000 people), patients have had rising levels of potassium or phosphates** in the blood. This can be treated by your doctor.
- **Pure red cell aplasia (PRCA) caused by neutralising antibodies has been observed during erythropoietin therapy,** including in isolated cases during therapy with NeoRecormon. PRCA means that the body stopped or reduced the production of red blood cells. This causes severe anaemia, symptoms of which would include unusual tiredness and a lack of energy. If your body produces neutralising antibodies, your doctor will discontinue therapy with NeoRecormon, and determine the best course of action to treat your anaemia.

Additional side effects in adults receiving chemotherapy for cancer

- **Increase in blood pressure and headaches** may occasionally occur. Your doctor may treat the high blood pressure with drugs.
- **An increase in the occurrence of blood clots** has been observed.

Additional side effects in people donating their own blood before surgery

- **A slight increase in the occurrence of blood clots** has been observed.

Reporting of side effects

If you get any side effects, talk to your doctor or pharmacist. This includes any possible side effects not listed in this leaflet. You can also report side effects directly via the Yellow Card Scheme Website: www.mhra.gov.uk/yellowcard or search for MHRA Yellow Card in the Google Play or Apple App Store. By reporting side effects you can help provide more information on the safety of this medicine.

5. How to store NeoRecormon

- Keep this medicine out of the sight and reach of children.
- Do not use NeoRecormon after the expiry date which is stated on the carton and label.
- Store in a refrigerator (2°C – 8°C).
- The syringe can be removed from the refrigerator and left at room temperature for a single period of maximum 3 days (but not above 25°C).
- Keep the pre-filled syringe in the outer carton, in order to protect from light.
- Medicines should not be disposed of via wastewater or household waste. Ask your pharmacist how to dispose of medicines no longer required. These measures will help protect the environment.

6. Contents of the pack and other information

What NeoRecormon contains

- The active substance is epoetin beta. One pre-filled syringe contains either 500, 2000, 3000, 4000, 5000, 6000, 10,000, 20,000 or 30,000 IU (international units) epoetin beta in 0.3 ml or 0.6 ml solution.
- The other ingredients are: urea, sodium chloride, polysorbate 20, sodium dihydrogen phosphate dihydrate, disodium phosphate dodecahydrate, calcium chloride dihydrate, glycine, L-Leucine, L-Isoleucine, L-Threonine, L-Glutamic acid, and L-Phenylalanine and water for injections (see section 2 “NeoRecormon contains phenylalanine and sodium”).

What NeoRecormon looks like and contents of the pack

NeoRecormon is a solution in a pre-filled syringe for injection
The solution is colourless, clear to slightly opalescent.

NeoRecormon 500 IU, 2000 IU, 3000 IU, 4000 IU, 5000 IU and 6000 IU: Each pre-filled syringe contains 0.3 ml solution.

NeoRecormon 10,000 IU, 20,000 IU and 30,000 IU: Each pre-filled syringe contains 0.6 ml solution.

NeoRecormon is provided in the following pack-sizes:

NeoRecormon 500 IU

1 pre-filled syringe with 1 needle (30G1/2) or
6 pre-filled syringes with 6 needles (30G1/2).

NeoRecormon 2000 IU, 3000 IU, 4000 IU, 5000 IU, 6000 IU, 10,000 IU and 20,000 IU

1 pre-filled syringe with 1 needle (27G1/2) or
6 pre-filled syringes with 6 needles (27G1/2).

NeoRecormon 30,000 IU

1 pre-filled syringe with 1 needle (27G1/2) or
4 pre-filled syringes with 4 needles (27G1/2).

Not all pack sizes may be marketed.

Marketing Authorisation Holder and Manufacturer
Roche Products Limited
6 Falcon Way, Shire Park
Welwyn Garden City
AL7 1TW
United Kingdom

This leaflet was last revised in June 2023

NeoRecormon pre-filled syringe Instructions for Use

The following instructions explain how to give an injection of NeoRecormon. Be sure that you read, understand and follow the Instructions for Use as well as the package leaflet before injecting NeoRecormon. Your healthcare provider will show you how to prepare and inject NeoRecormon properly before you use it for the first time.

Do not inject yourself unless you have received training. Consult your healthcare provider if you require further information.

Always follow all directions in these Instructions for Use as they may differ from your experiences. These instructions will minimize risk such as accidental needle stick and prevent incorrect use.

NeoRecormon can be administered through 2 manners, your doctor will decide which way is right for you:

- Intravenous administration (into the vein or vein port), only to be performed by healthcare professionals.
- Subcutaneous administration (under the skin).

Before you begin

- **Do not** take the needle cap off until you are ready to inject NeoRecormon.
- **Do not** try to take the syringe apart at any time.
- **Do not** reuse the same syringe.
- **Do not** use if the syringe has been dropped or damaged.
- **Do not** leave the syringe unattended.
- Keep the syringe and needle and the puncture-resistant or sharps disposal container out of reach of children.
- Contact your healthcare professional if you have any questions.

Storage Instructions

- Keep your unused syringe(s) and needles in the original carton and store in a refrigerator at 2°C to 8°C.
- Keep your syringe and needle out of direct sunlight.
- **Do not** freeze.
- **Do not** use if the syringe has been frozen.
- Always keep the syringe and needle dry.

Supplies needed to give your injection

Included in the carton:

- NeoRecormon Pre-filled syringe(s).

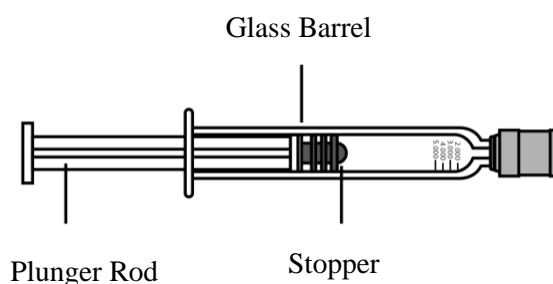

- Injection needle(s) (27G or 30G) (depending on the prescribed strengths of the medicine) with safety shield (used for priming, setting the dose and injecting the medicine).

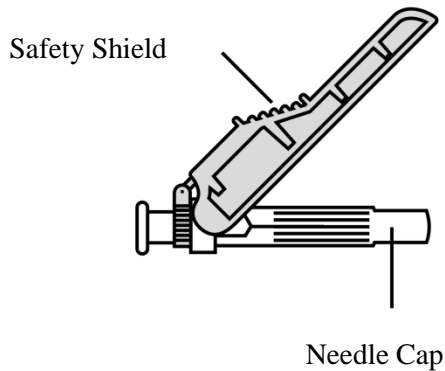

Note: Each NeoRecormon carton contains either 1 syringe/1 needle, 4 syringes/4 needles or 6 syringes/6 needles.

- Instructions for Use and a package leaflet.

Not included in the carton:

- 1 alcohol swab.
- 1 dry sterile pad.
- 1 puncture-resistant container or sharps container for safe disposal of rubber cap, needle cap and used syringe.

Preparing for injection

- 1 Find a well lit, clean, flat, working surface.
 - Take the carton with the syringe(s) and needle(s) out of the refrigerator
- 2 Check the carton, the perforations on the front of the carton and the seal. Also check the expiration date.

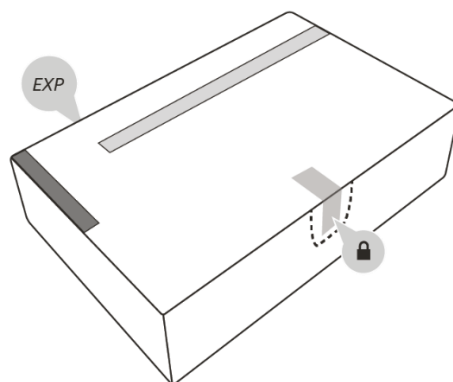

- **Do not** use if the expiration date has passed, or if the carton looks damaged. In this case, proceed to *step 20* and contact your healthcare provider.
 - **Do not** use if the perforations or the seal are broken. In this case, proceed to *step 20* and contact your healthcare provider.
- 3 Open the carton by pushing through the perforation around the seal.

- 4 Take one syringe out of the carton and one needle from the needle box. Be careful when taking out the syringe. Make sure you always hold the syringe as shown in the picture below.
- **Do not** flip the carton upside down to remove the syringe.
 - **Do not** handle the syringe by holding the plunger or needle cap.

Remark: If you have a multipack, put the carton with the remaining syringe(s) and needle(s) back into the refrigerator

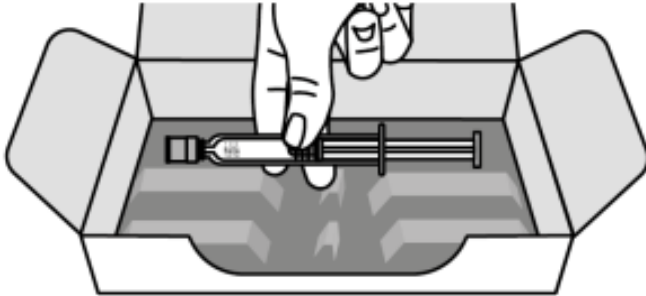

- 5 Inspect the syringe and needle closely
- Check the syringe and needle for any damage. **Do not** use the syringe if you have dropped the syringe or if any part of the syringe appears to be damaged.
 - Check the expiration date on the syringe and the needle. **Do not** use the syringe or the needle if the expiration date has passed.
 - Check the liquid in the syringe. The liquid should be clear and colourless. **Do not** use the syringe if the liquid is cloudy, discoloured, or has particles.
- 6 Place the syringe on a clean, flat surface.
- Set aside the syringe for 30 minutes so it can warm up on its own to room temperature. Leave the needle cap on while it warms up.
 - **Do not** speed up the warming process in any way, and **do not** put the syringe in a microwave or in warm water.

Remark: If the syringe does not reach room temperature, this could cause the injection to feel uncomfortable and make it hard to push the plunger.

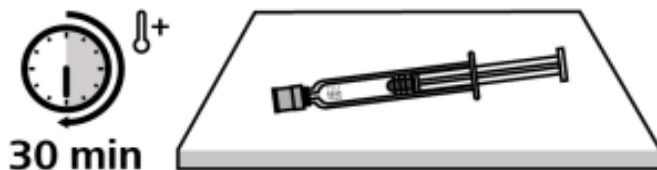

- 7 Attach the needle to the syringe.
- Remove the needle from its blister.
 - Pull the rubber cap off the end of the syringe (A).
 - Dispose of the rubber cap in a puncture-resistant or sharps container immediately.
 - **Do not** touch the tip of the syringe.
 - **Do not** push or pull the plunger.
 - Hold the syringe by the barrel and push the needle onto the syringe (B).
 - Gently twist until it is fully attached (C)

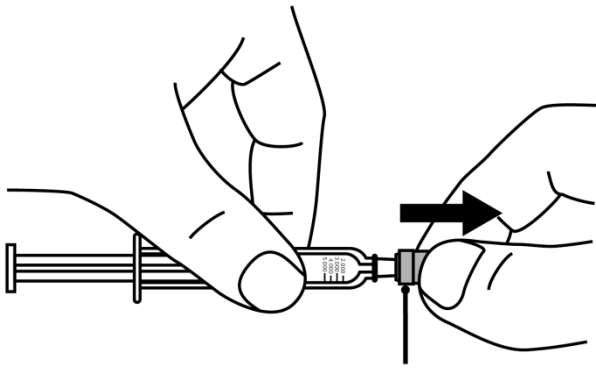

A) Rubber Cap

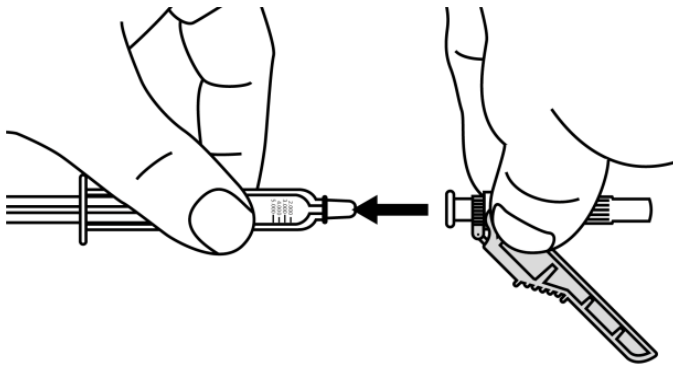

B)

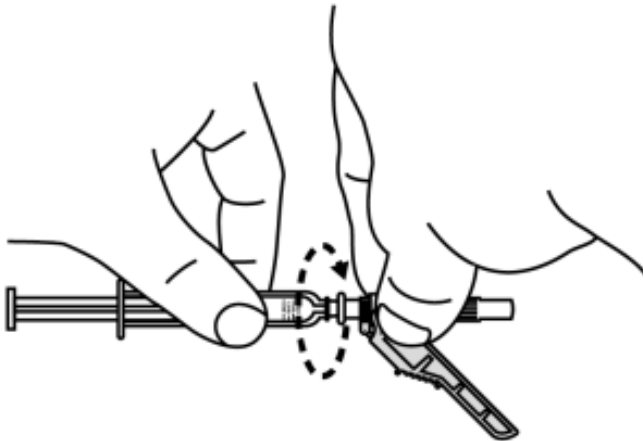

C)

8 Place the syringe on a clean, flat surface until ready for use.

9 Wash your hands with soap and water.

10 Choose an injection site:

- The recommended injection sites are the top of your thigh or the lower part of your abdomen below the belly button.
- **Do not** inject within the 5 cm (2 inches) area directly around your belly button.
- Choose a different injection site for each new injection.
- **Do not** inject into moles, scars, bruises, or areas where the skin is tender, red, hard or not intact.
- **Do not** inject into vein or into a muscle

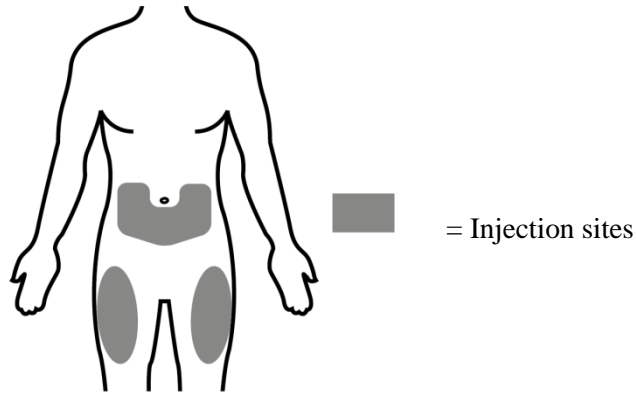

11 Wipe the injection site with an alcohol swab and let it air dry for 10 seconds.

- **Do not** fan or blow on the cleaned area.
- **Do not** touch the injection site again before giving the injection.



Administering the subcutaneous injection

12 Move the safety shield away from the needle in the direction towards the syringe barrel.

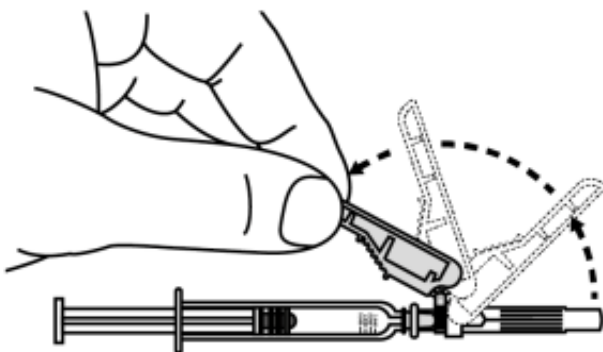

13 Hold the syringe and needle tightly at the hub and carefully pull the injection needle cap away from the syringe. Use the syringe within 5 minutes of removing the cap; otherwise, the needle may clog.

- **Do not** hold the plunger while you remove the needle cap.
- **Do not** touch the needle after removing the needle cap.
- **Do not** re-cap the needle.
- **Do not** straighten needle if needle is bent or damaged.

Throw away the needle cap in a sharps container immediately.

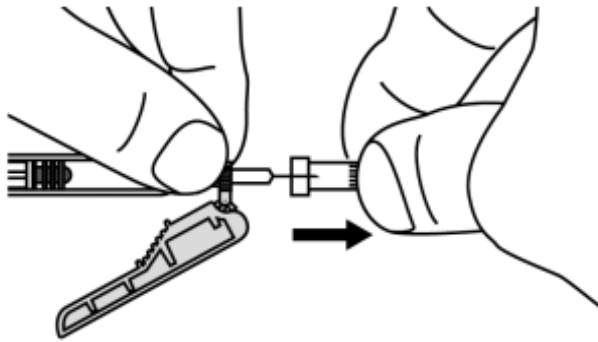

14 Hold the syringe with the needle pointing up. Remove the larger air bubbles by gently tapping the syringe barrel with your fingers until the air bubbles rise to the top of the syringe. Then, slowly push the plunger up to push the air bubbles out of the syringe.

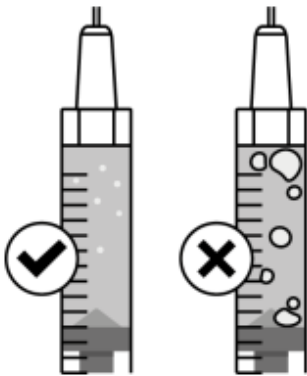

15 Adjust to your prescribed dose by slowly pushing the plunger.

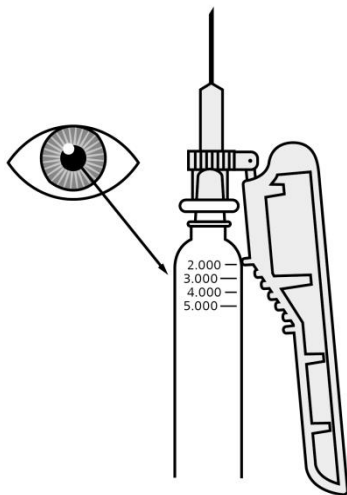

16 Pinch the selected injection site and fully insert the needle at a 45° to 90° angle with a quick, firm action.

- **Do not** touch the plunger while inserting the needle into the skin
- **Do not** insert the needle through clothing.

Once the needle is inserted, release the pinch and hold the syringe tightly in place.

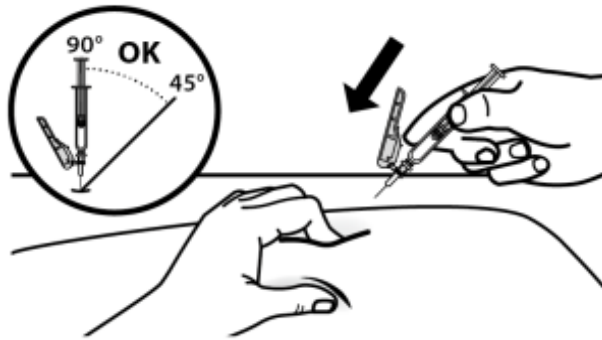

- 17 Slowly inject your prescribed dose by gently pushing the plunger all the way down
- Remove the needle and syringe from the injection site at the same angle as inserted.

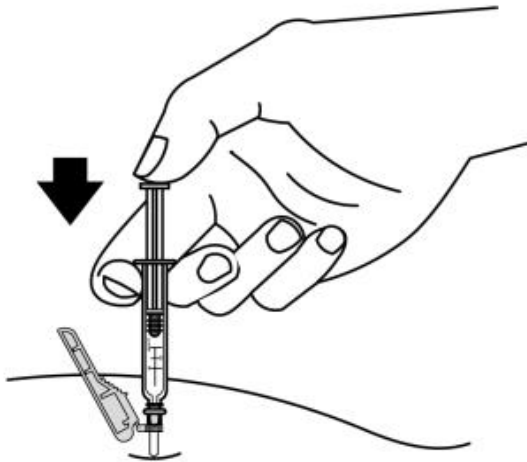

After the injection

- 18 There may be a little bleeding at the injection site. You can press a dry sterile pad over the injection site. **Do not** rub the injection site.
- If needed, you may cover the injection site with a small bandage.
 - In case of skin contact with medicine, wash the area that touched the medicine with water.

19 Move the safety shield forward 90°, away from the syringe barrel (A). Holding the syringe with one hand, press the safety shield down against a flat surface with a firm, quick motion until you hear a “click” (B).

- If you do not hear a click, look to see that the needle is fully covered by the safety shield.
- Keep your fingers behind the safety shield and away from the needle at all times.

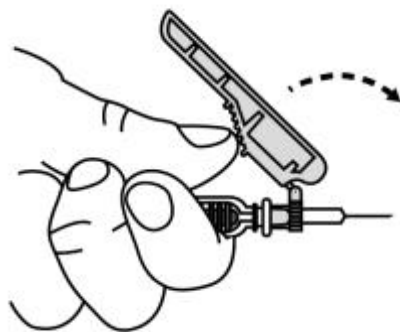

A)

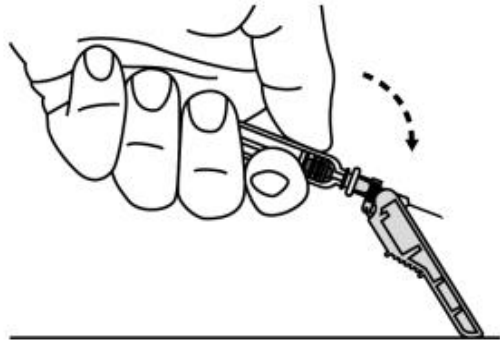

B)

20 Put your used syringe in a sharps disposal container right away after use.

- **Do not** try to remove the used injection needle from the used syringe.
- **Do not** recap the injection needle with the cap.
- **Do not** throw away (dispose of) the syringe in your household trash.

Important: Always keep the sharps disposal container out of the reach of children.

<-----
--->

Instructions for Use for intravenous injection, intended for healthcare professional only

The following Instructions for Use explain how to give an intravenous injection of NeoRecormon. Be sure that you read, understand and follow the Instructions for Use as well as the package leaflet before injecting NeoRecormon.

Administering the intravenous injection (healthcare professional only)

Preparing for injection: follow steps 1 to 9 of subcutaneous injection (above).

10 Select a vein. Change vein with each injection to prevent soreness in one spot.

- **Do not** inject into a red or swollen area.
- **Do not** inject into a muscle.

Clean the skin above the vein with an alcohol swab and let dry.

- **Do not** fan or blow on the cleaned area.
- **Do not** touch the injection site again before giving the injection.

11 Prepare the syringe and needle: follow steps 12 to 15 of subcutaneous injection (above).

16 Insert the needle into the vein.

- **Do not** hold or push on the plunger while inserting needle.

17 Slowly inject the prescribed dose by gently pushing the plunger all the way down. Remove the needle and syringe from the injection site at the same angle as inserted.

After the injection: follow steps 18 to 20 of subcutaneous injection (above).

Administering the intravenous injection via injection port (healthcare professional only)

Preparing for injection: follow steps 1 to 9 of subcutaneous injection (above).

10 Clean the skin above the injection port with an alcohol swab and let dry.

Clean the injection port as instructed by the provider.

- **Do not** fan or blow on the cleaned area.
- **Do not** touch the injection site again before giving the injection.

11 Prepare the syringe and needle: follow steps 12 to 15 of subcutaneous injection (above).

16 Insert the needle into the injection port (follow the instruction of the injection port provider)

- **Do not** hold or push on the plunger while inserting needle.

17 Slowly inject the prescribed dose by gently pushing the plunger all the way down. Remove the needle and syringe from the injection port at the same angle as inserted.

After the injection: follow steps 18 to 20 of subcutaneous injection (above).